

PER:
FOR: **ABUS (DE)**

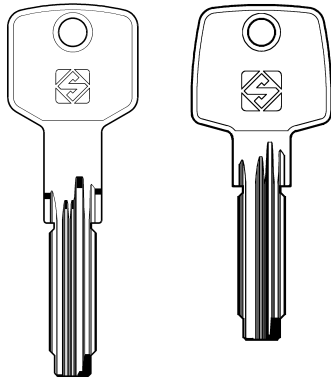

AB48

AB84

AB74

ASTRAL system:

Codes tables protected by a password issued by Silca on receipt of the manufacturer's authorization.

Tabella codici protette da password rilasciata da Silca a fronte di autorizzazione del costruttore.

Code-Tabellen geschützt durch von Silca geliefertes Password auf Herstellersgenehmigung.

Tables de codes protégées par un password qui est émis par Silca sur autorisation du Constructeur.

Tablas códigos protegidos por password que expide Silca contra autorización del constructor.

Tabelas de códigos protegidas por uma password emitida por Silca contra autorização do fabricante.

OPTIONAL



D743261ZB

05J Jaw
Ganascia 05J
05J Backe
Mâchoire 05J
Quijada 05J
Garra 05J



OPTIONAL



D743262ZB

06J Jaw
Ganascia 06J
06J Backe
Mâchoire 06J
Quijada 06J
Garra 06J

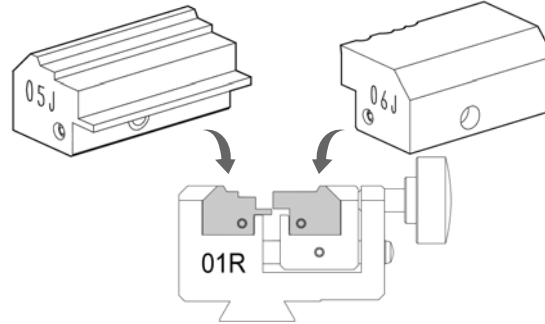

STANDARD



D742867ZB

Cutter 01D
Fresa 01D
Fräser 01D
Fraise 01D
Fresa 01D
Fresa 01D

PER:
FOR: **ABUS (DE)**

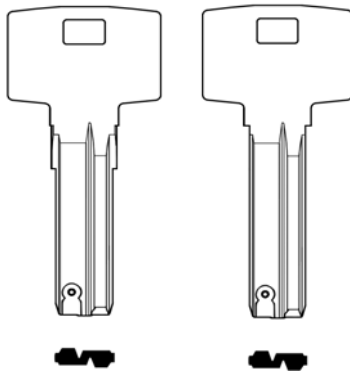

(Bravus)
(1000 - 2000 - 3000 - 4000)

System protected by a password issued by Silca on receipt of authorization.

Sistema protetto da password rilasciata da Silca a fronte di autorizzazione.

System geschützt durch von Silca geliefertes Password auf Genehmigung.

Système protégé par un password qui est émis par Silca sur autorisation.

Sistema protegido con contraseña que manda Silca previa autorización.

Sistema protegido por uma password emitida por Silca contra a autorização.

OPTIONAL



D744315ZB

29J Jaw
Ganascia 29J
29J Backe
Mâchoire 29J
Quijada 29J
Garra 29J



OPTIONAL



D744317ZB

30J Jaw
Ganascia 30J
30J Backe
Mâchoire 30J
Quijada 30J
Garra 30J

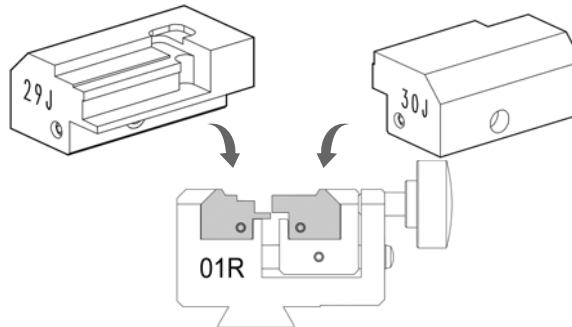

1000 - 2000 - 3000 systems

OPTIONAL



D744355ZB

Cutter 07D
Fresa 07D
Fräser 07D
Fraise 07D
Fresa 07D
Fresa 07D

4000 system

OPTIONAL



D744355ZB

Cutter 07D
Fresa 07D
Fräser 07D
Fraise 07D
Fresa 07D
Fresa 07D

OPTIONAL



D743672ZB

Cutter 03L
Fresa 03L
Fräser 03L
Fraise 03L
Fresa 03L
Fresa 03L

FOR:
PER:

ABUS (DE)

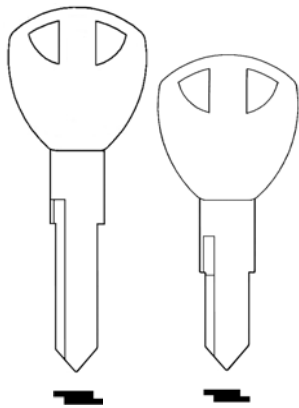

(Abus Bike)
(8N - 6N)

OPTIONAL D751310ZB



92J Jaw
Ganascia 92J
92J Backe
Mâchoire 92J
Quijada 92J
Garra 92J

OPTIONAL D751330ZB



93J Jaw
Ganascia 93J
93J Backe
Mâchoire 93J
Quijada 93J
Garra 93J

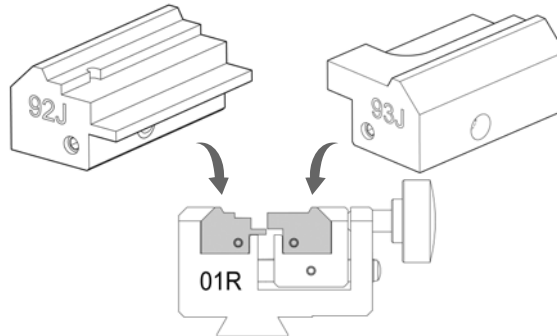

OPTIONAL



D751336ZB

Cutter 09L
Fresa 09L
Fräser 09L
Fraise 09L
Fresa 09L
Fresa 09L

PER:
FOR:

ASSA (SE)

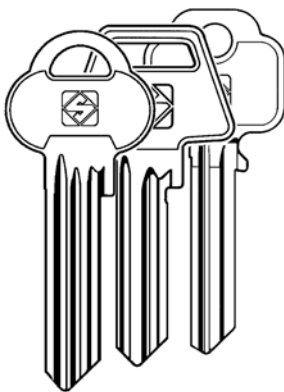

6-7 PIN KEYS

(DP, CLIQ)
(D-12)

OPTIONAL

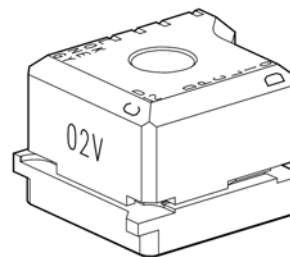

D743271ZB

02V clamp for ASSA type keys (long keys, D-12*, DP, CLIQ)
Morsetto 02V per chiavi tipo ASSA (chiavi lunghe, D-12*, DP, CLIQ)
Spannbacke 02V für ASSA Schlüsseltyp (lange Schlüssel, D-12*, DP, CLIQ)
Etau 02V pour clés type ASSA (clés longues, D-12*, DP, CLIQ)
Mordaza 02V para llaves de tipo ASSA (llaves largas, D-12*, DP, CLIQ)
Mordente 02V para chaves do tipo ASSA (chaves longas, D-12*, DP, CLIQ)

*D-12: Key duplicable by code only
*D-12: Chiave duplicabile solo a codice
*D-12: Kopierenschlüssel nur zur Code
*D-12: Clé à copier uniquement par code
*D-12: Llave duplicable sólo a código
*D-12: Chave duplicable somente por código

PER:
FOR:

ASSA (SE)

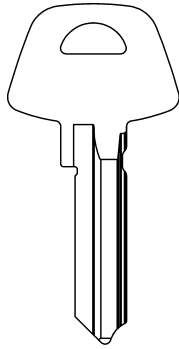

System protected by a password issued by Silca on receipt of authorization.

Sistema protetto da password rilasciata da Silca a fronte di autorizzazione.

System geschützt durch von Silca geliefertes Password auf Genehmigung.

Système protégé par un password qui est émis par Silca sur autorisation.

Sistema protegido con contraseña que manda Silca previa autorización.

Sistema protegido por uma password emitida por Silca contra a autorização.

OPTIONAL D744283ZB



20J Jaw
Ganascia 20J
20J Backe
Mâchoire 20J
Quijada 20J
Garra 20J

OPTIONAL D744284ZB



21J Jaw
Ganascia 21J
21J Backe
Mâchoire 21J
Quijada 21J
Garra 21J

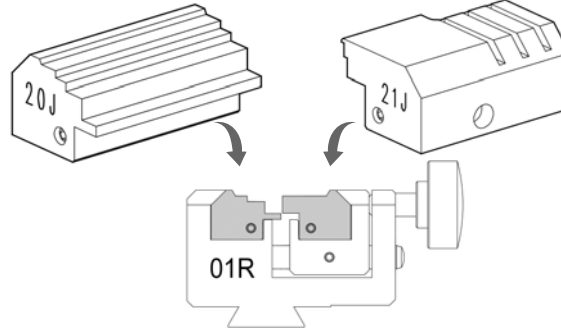

OPTIONAL



D743745ZB

Cutter 04L
Fresa 04L
Fräser 04L
Fraise 04L
Fresa 04L
Fresa 04L

PER:
FOR:

ASSA (SE)

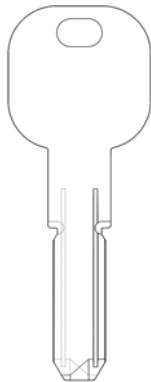

SYSTEM	CARD	SN
ASSA ABLOY K100	4239	1870
IKON RW6	4239	1871
Union keyPRIME™	4239	1873
Vachette Vercy	4239	1877
ASSA ABLOY CY110	4239	1874
IKONRW6 (Main+Side Row)	4241	1875

System protected by a password issued by Silca on receipt of authorization.

Sistema protetto da password rilasciata da Silca a fronte di autorizzazione.

System geschützt durch von Silca geliefertes Password auf Genehmigung.

Système protégé par un password qui est émis par Silca sur autorisation.

Sistema protegido con contraseña que manda Silca previa autorización.

Sistema protegido por uma password emitida por Silca contra a autorização.

OPTIONAL D749002ZB



86J Jaw
Ganascia 86J
86J Backe
Mâchoire 86J
Quijada 86J
Garra 86J

OPTIONAL D749004ZB



87J Jaw
Ganascia 87J
87J Backe
Mâchoire 87J
Quijada 87J
Garra 87J

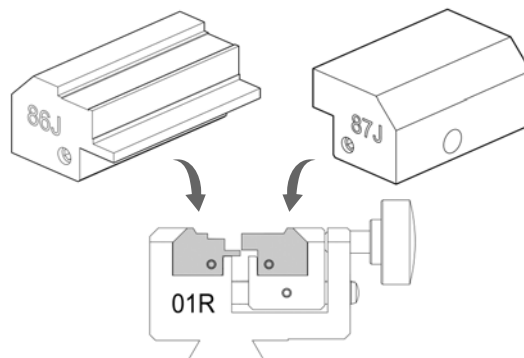

STANDARD



D742867ZB

Cutter 01D
Fresa 01D
Fräser 01D
Fraise 01D
Fresa 01D
Fresa 01D

FUTURA PRO UNLIMITED



PER:
FOR:

BKS (DE)

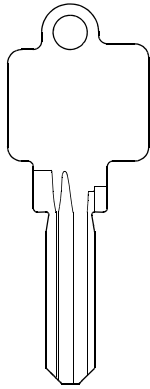

WS42
(WS42)

OPTIONAL



D744485ZB

39J Jaw
Ganascia 39J
39J Backe
Mâchoire 39J
Quijada 39J
Garra 39J

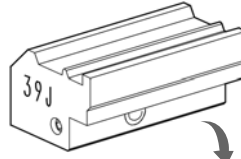

OPTIONAL



D744482ZB

38J Jaw
Ganascia 38J
38J Backe
Mâchoire 38J
Quijada 38J
Garra 38J

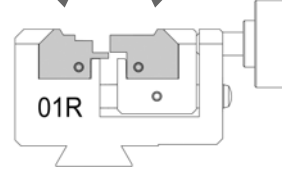
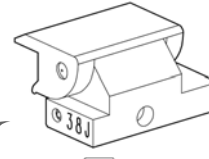

OPTIONAL



D744514ZB

Cutter 08L
Fresa 08L
Fräser 08L
Fraise 08L
Fresa 08L
Fresa 08L

PER:
FOR:

BKS (DE)

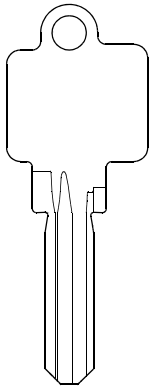

WS50 MK
(Profiles RA-RK-RZ)

OPTIONAL



D744480ZB

37J Jaw
Ganascia 37J
37J Backe
Mâchoire 37J
Quijada 37J
Garra 37J

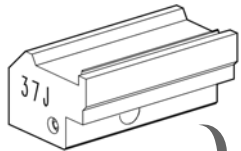

OPTIONAL



D744482ZB

38J Jaw
Ganascia 38J
38J Backe
Mâchoire 38J
Quijada 38J
Garra 38J

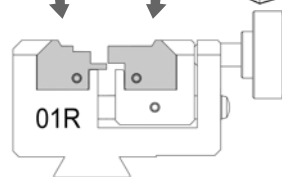
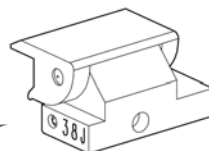

OPTIONAL



D744514ZB

Cutter 08L
Fresa 08L
Fräser 08L
Fraise 08L
Fresa 08L
Fresa 08L



PER:
FOR:

CES (DE)

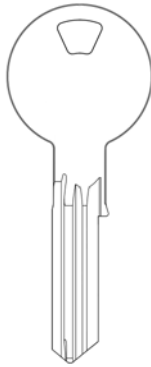

(UDM)

System protected by a password issued by Silca on receipt of authorization.

Sistema protetto da password rilasciata da Silca a fronte di autorizzazione.

System geschützt durch von Silca geliefertes Passwort auf Genehmigung.

Système protégé par un password qui est émis par Silca sur autorisation.

Sistema protegido con contraseña que manda Silca previa autorización.

Sistema protegido por uma password emitida por Silca contra a autorização.

OPTIONAL



D744505ZB

49J Jaw
Ganascia 49J
49J Backe
Mâchoire 49J
Quijada 49J
Garra 49J



OPTIONAL



D744311ZB

25J Jaw
Ganascia 25J
25J Backe
Mâchoire 25J
Quijada 25J
Garra 25J

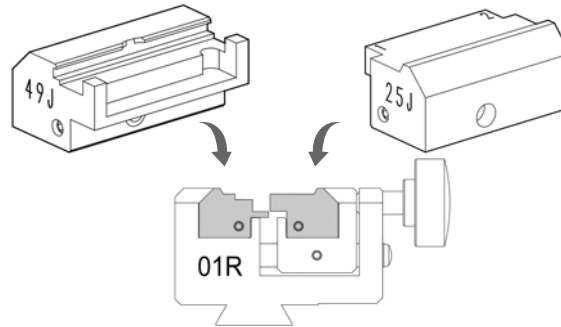

OPTIONAL



D744513ZB

Cutter 12D
Fresa 12D
Fräser 12D
Fraise 12D
Fresa 12D
Fresa 12D

PER:
FOR:

CES (DE)

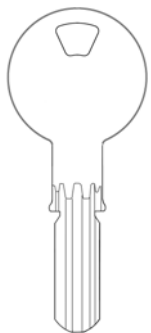

(WSM NEW)

System protected by a password issued by Silca on receipt of authorization.

Sistema protetto da password rilasciata da Silca a fronte di autorizzazione.

System geschützt durch von Silca geliefertes Passwort auf Genehmigung.

Système protégé par un password qui est émis par Silca sur autorisation.

Sistema protegido con contraseña que manda Silca previa autorización.

Sistema protegido por uma password emitida por Silca contra a autorização.

STANDARD



D943253ZR

01J Jaw
Ganascia 01J
01J Backe
Mâchoire 01J
Quijada 01J
Garra 01J



STANDARD



D943254ZR

02J Jaw
Ganascia 02J
02J Backe
Mâchoire 02J
Quijada 02J
Garra 02J

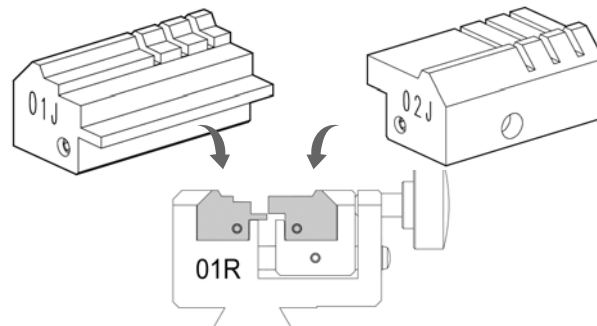

OPTIONAL



D744510ZB

Cutter 11D
Fresa 11D
Fräser 11D
Fraise 11D
Fresa 11D
Fresa 11D

PER:
FOR:

CISA (IT)



CS70P

CS70

CS62

ASTRAL
(system 357)

AB48
ABUS

OPTIONAL

D743261ZB



05J Jaw
Ganascia 05J
05J Backe
Mâchoire 05J
Quijada 05J
Garra 05J



OPTIONAL

D743262ZB



06J Jaw
Ganascia 06J
06J Backe
Mâchoire 06J
Quijada 06J
Garra 06J

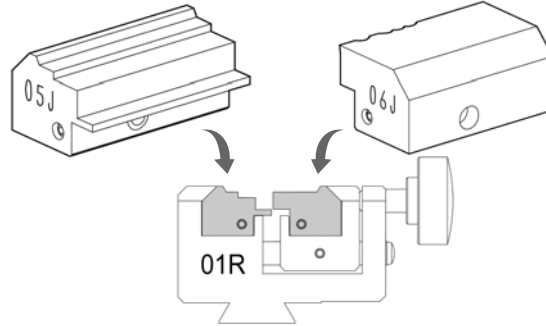

STANDARD



D742867ZB

Cutter 01D
Fresa 01D
Fräser 01D
Fraise 01D
Fresa 01D
Fresa 01D

ASTRAL system:

Codes tables protected by a password issued by Silca on receipt of the manufacturer's authorization.

Tabelle codici protette da password rilasciata da Silca a fronte di autorizzazione del costruttore.

Code-Tabellen geschützt durch von Silca geliefertes Password auf Herstellersgenehmigung.

Tables de codes protégées par un password qui est émis par Silca sur autorisation du Constructeur.

Tablas codigos protegidos con contraseña que manda Silca previa autorización.

Tabelas de códigos protegidas por uma password emitida por Silca contra autorização do fabricante.

PER:
FOR:

DOM (DE)

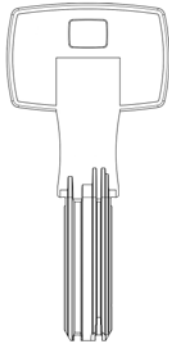

(IX Teco) (IX7TE)

SYSTEM	CARD	SN
Dom IX TECO Prf. 270	4566	2087
Dom IX TECO Prf. 271	4567	2088
Dom IX7TE Prf. 278	4568	2089
Dom IX7TE Prf. 274	4569	2090
Dom IX7TE Prf. 275	4570	2091
Dom IX7TE Prf. 273	4571	2092

System protected by a password issued by Silca on receipt of authorization.

Sistema protetto da password rilasciata da Silca a fronte di autorizzazione.

System geschützt durch von Silca geliefertes Password auf Genehmigung.

Système protégé par un password qui est émis par Silca sur autorisation.

Sistema protegido con contraseña que manda Silca previa autorización.

Sistema protegido por uma password emitida por Silca contra a autorização.

OPTIONAL

D7A0408ZB



108 Jaw
Ganascia 108
108 Backe
Mâchoire 108
Quijada 108
Garra 108

OPTIONAL

D7A1178ZB



109 Jaw
Ganascia 109
109 Backe
Mâchoire 109
Quijada 109
Garra 109

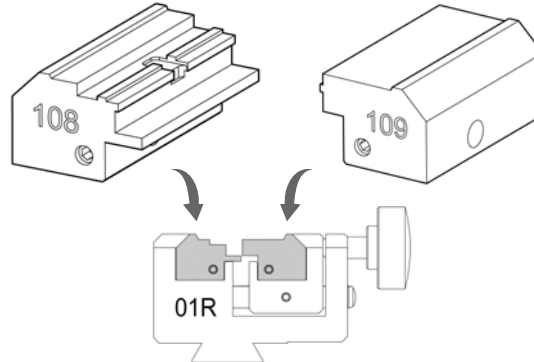

OPTIONAL



D744508ZB

Cutter 09D
Fresa 09D
Fräser 09D
Fraise 09D
Fresa 09D
Fresa 09D

PER:
FOR:

DOM (DE)

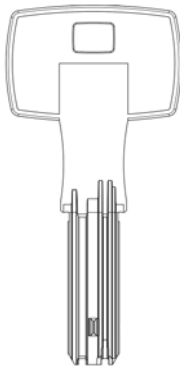

(IX Twido) (IX7TW)

SYSTEM	CARD	SN
Dom IX Twido Prf. 280	4506	2052
Dom IX Twido Prf. 281	4507	2053
Dom IX7TW Prf. 282	4508	2054
Dom IX7TW Prf. 283	4509	2055
Dom IX7TW Prf. 284	4510	2056
Dom IX7TW Prf. 285	4511	2057
Dom IX7TW Prf. 288	4588	2094

System protected by a password issued by Silca on receipt of authorization.

Sistema protetto da password rilasciata da Silca a fronte di autorizzazione.

System geschützt durch von Silca geliefertes Password auf Genehmigung.

Système protégé par un password qui est émis par Silca sur autorisation.

Sistema protegido con contraseña que manda Silca previa autorización.

Sistema protegido por uma password emitida por Silca contra a autorização.

OPTIONAL

D752534ZB



97J Jaw
Ganascia 97J
97J Backe
Mâchoire 97J
Quijada 97J
Garra 97J

OPTIONAL

D752536ZB



98J Jaw
Ganascia 98J
98J Backe
Mâchoire 98J
Quijada 98J
Garra 98J

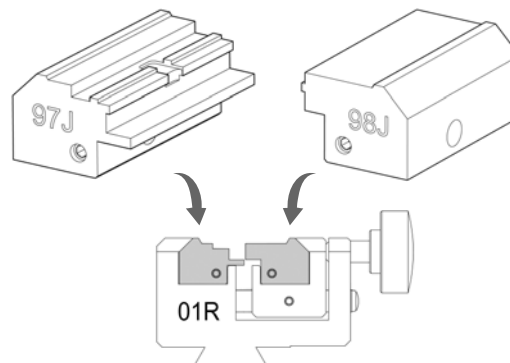

OPTIONAL



D744508ZB

Cutter 09D
Fresa 09D
Fräser 09D
Fraise 09D
Fresa 09D
Fresa 09D

PER:
FOR:

DOM (DE)

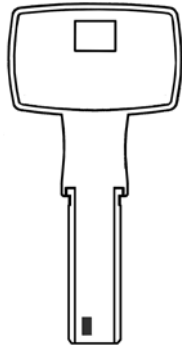

(IX-SATS)

SYSTEM	CARD	SN
Dom IX SATS (Pr. 169)	3789	1507
Dom IX SATS (Pr. 170)	3790	1508
Dom IX SATS (Pr. 171)	3791	1509
Dom IX SATS (Pr. 172)	3792	1510
Dom IX SATS (Pr. 167)	3929	1644
Dom IX SATS (Pr. 169-170-171-172) (Precoded)	3788	1506

System protected by a password issued by Silca on receipt of authorization.

Sistema protetto da password rilasciata da Silca a fronte di autorizzazione.

System geschützt durch von Silca geliefertes Password auf Genehmigung.

Système protégé par un password qui est émis par Silca sur autorisation.

Sistema protegido con contraseña que manda Silca previa autorización.

Sistema protegido por uma password emitida por Silca contra a autorização.

OPTIONAL D751041ZB



91J Jaw
Ganascia 91J
91J Backe
Mâchoire 91J
Quijada 91J
Garra 91J



STANDARD D943254ZR



02J Jaw
Ganascia 02J
02J Backe
Mâchoire 02J
Quijada 02J
Garra 02J

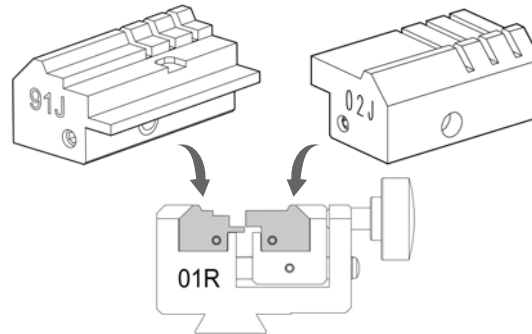

OPTIONAL

D744508ZB



Cutter 09D
Fresa 09D
Fräser 09D
Fraise 09D
Fresa 09D
Fresa 09D

PER:
FOR:

DOM (DE)

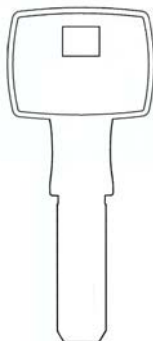

(IX6SR E)

(prof. 129, 130, 241)

(prof. 131, 132, 233)

(prof. 230, 232 AT, 234 AT, 235)

System protected by a password issued by Silca on receipt of authorization.

Sistema protetto da password rilasciata da Silca a fronte di autorizzazione.

System geschützt durch von Silca geliefertes Password auf Genehmigung.

Système protégé par un password qui est émis par Silca sur autorisation.

Sistema protegido con contraseña que manda Silca previa autorización.

Sistema protegido por uma password emitida por Silca contra a autorização.

OPTIONAL



D744495ZB

44J Jaw
Ganascia 44J
44J Backe
Mâchoire 44J
Quijada 44J
Garra 44J



STANDARD

D943254ZR

02J Jaw
Ganascia 02J
02J Backe
Mâchoire 02J
Quijada 02J
Garra 02J

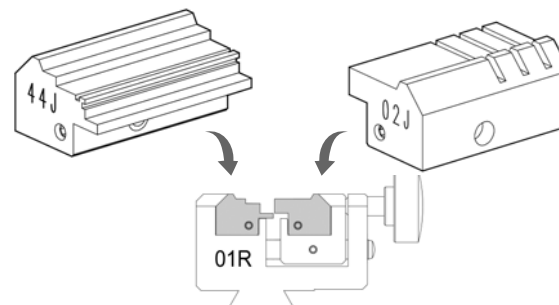

OPTIONAL

D744508ZB



Cutter 09D
Fresa 09D
Fräser 09D
Fraise 09D
Fresa 09D
Fresa 09D

PER:
FOR:

DOM (DE)

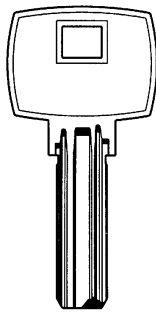

(IXGAMMA)
(prof. 154)

System protected by a password issued by Silca on receipt of authorization.

Sistema protetto da password rilasciata da Silca a fronte di autorizzazione.

System geschützt durch von Silca geliefertes Password auf Genehmigung.

Système protégé par un password qui est émis par Silca sur autorisation.

Sistema protegido con contraseña que manda Silca previa autorización.

Sistema protegido por uma password emitida por Silca contra a autorização.

OPTIONAL



D744499ZB

46J Jaw
Ganascia 46J
46J Backe
Mâchoire 46J
Quijada 46J
Garra 46J

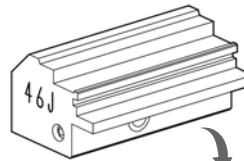

OPTIONAL



D744497ZB

45J Jaw
Ganascia 45J
45J Backe
Mâchoire 45J
Quijada 45J
Garra 45J

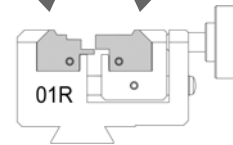
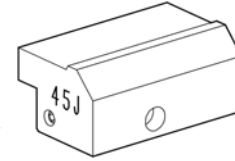

OPTIONAL



D744508ZB

Cutter 09D
Fresa 09D
Fräser 09D
Fraise 09D
Fresa 09D
Fresa 09D

PER:
FOR:

DOM (DE)

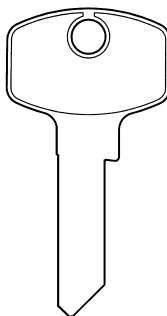

(Prof. 145)

SIGMA

System protected by a password issued by Silca on receipt of authorization.

Sistema protetto da password rilasciata da Silca a fronte di autorizzazione.

System geschützt durch von Silca geliefertes Password auf Genehmigung.

Système protégé par un password qui est émis par Silca sur autorisation.

Sistema protegido con contraseña que manda Silca previa autorización.

Sistema protegido por uma password emitida por Silca contra a autorização.

OPTIONAL



D744319ZB

31J Jaw
Ganascia 31J
31J Backe
Mâchoire 31J
Quijada 31J
Garra 31J

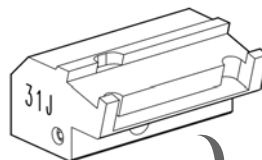

OPTIONAL



D744321ZB

32J Jaw
Ganascia 32J
32J Backe
Mâchoire 32J
Quijada 32J
Garra 32J

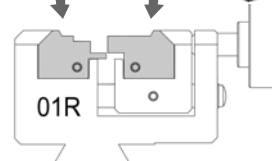
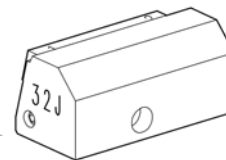

OPTIONAL



D744354ZB

Cutter 05D
Fresa 05D
Fräser 05D
Fraise 05D
Fresa 05D
Fresa 05D

Note: standard cutting is also required.
Nota: è necessaria anche la cifratura standard.
Hinweis: Standard Fräsung ist auch erforderlich.
Remarque: il faut aussi nécessaire le taillage standard.
Nota: también es necesario el corte estándar.
Observação: o corte standard es também necessário

PER:
FOR:

DOM (DE) CORBIN (IT)

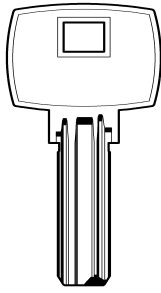

(IX5 DAS)
(prof. 038/101)

OPTIONAL



D744487ZB

40J Jaw
Ganascia 40J
40J Backe
Mâchoire 40J
Quijada 40J
Garra 40J



OPTIONAL



D744489ZB

41J Jaw
Ganascia 41J
41J Backe
Mâchoire 41J
Quijada 41J
Garra 41J

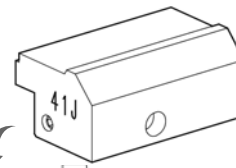
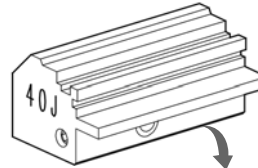

STANDARD



D742867ZB

Cutter 01D
Fresa 01D
Fräser 01D
Fraise 01D
Fresa 01D
Fresa 01D

PER:
FOR:

DOM (DE) CORBIN (IT)

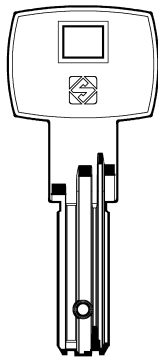

DM144
(IX6 KG Profile 121)

OPTIONAL



D743269ZB

09J Jaw
Ganascia 09J
09J Backe
Mâchoire 09J
Quijada 09J
Garra 09J



OPTIONAL



D743270ZB

10J Jaw
Ganascia 10J
10J Backe
Mâchoire 10J
Quijada 10J
Garra 10J

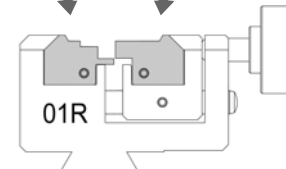
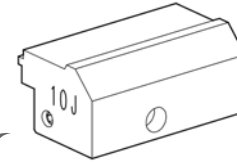
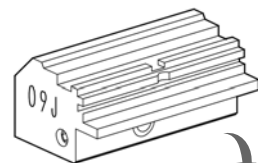

STANDARD



D742867ZB

Cutter 01D
Fresa 01D
Fräser 01D
Fraise 01D
Fresa 01D
Fresa 01D

FOR:
PER:

DOM (DE)

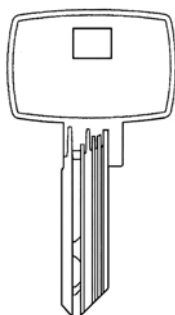

(RS8)

OPTIONAL



D744762ZB

05V clamp for DOM RS8 type keys
Morsetto 05V per chiavi tipo DOM RS8
Spannbacke 05V für DOM RS8 Schlüsseltyp
Etau 05V pour clés type DOM RS8
Mordaza 05V para llaves de tipo DOM RS8
Mordente 05V para chaves do tipo DOM RS8

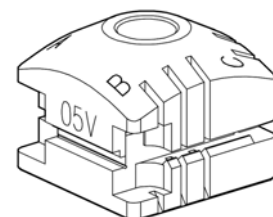

FOR:
PER:

EVVA (AT)

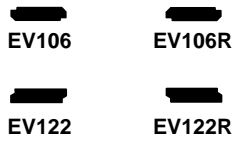
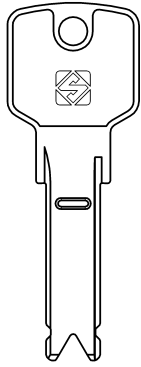

Silca SK3

SIDE



OPTIONAL D743263ZB
 CODE
 COPY
 07J Jaw
 Ganascia 07J
 07J Backe
 Mâchoire 07J
 Quijada 07J
 Garra 07J

OPTIONAL D743264ZB
 CODE
 COPY
 08J Jaw
 Ganascia 08J
 08J Backe
 Mâchoire 08J
 Quijada 08J
 Garra 08J

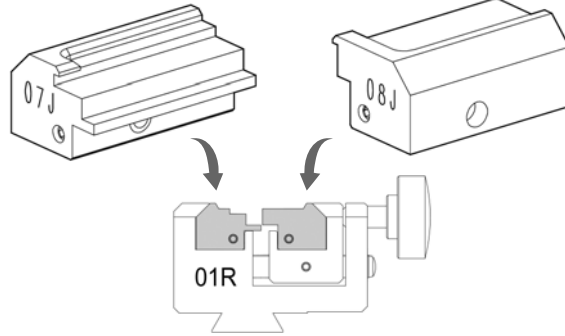

OPTIONAL D745913ZB
 05T
 Tracer 05T
 Tastatore 05T
 Taster 05T
 Palpeur 05T
 Palpador 05T
 Palpador 05T

OPTIONAL D743745ZB
 04L
 Cutter 04L
 Fresa 04L
 Fräser 04L
 Fraise 04L
 Fresa 04L
 Fresa 04L

BACK



STANDARD D943253ZR
 CODE
 COPY
 01J Jaw
 Ganascia 01J
 01J Backe
 Mâchoire 01J
 Quijada 01J
 Garra 01J

STANDARD D943254ZR
 CODE
 COPY
 02J Jaw
 Ganascia 02J
 02J Backe
 Mâchoire 02J
 Quijada 02J
 Garra 02J

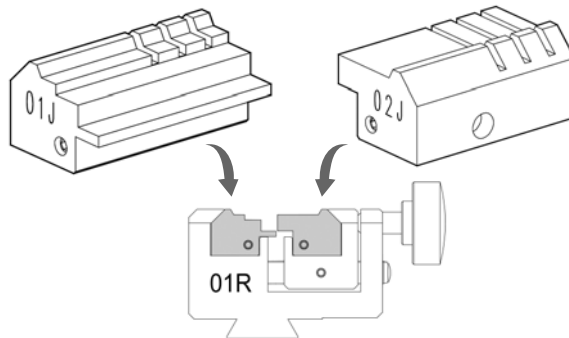

STANDARD D942565ZR
 01T
 Tracer 01T
 Tastatore 01T
 Taster 01T
 Palpeur 01T
 Palpador 01T
 Palpador 01T

STANDARD D742867ZB
 01D
 Cutter 01D
 Fresa 01D
 Fräser 01D
 Fraise 01D
 Fresa 01D
 Fresa 01D

PER:
FOR:

HUWIL (DE)

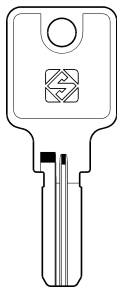

HW15R

OPTIONAL D743362ZB

- ◆ CODE 16J Jaw
- ◆ CODE Ganascia 16J
- ◇ COPY 16J Backe
- ◇ COPY Mâchoire 16J
- ◇ COPY Quijada 16J
- ◇ COPY Garra 16J

OPTIONAL D743365ZB

- ◆ CODE 17J Jaw
- ◆ CODE Ganascia 17J
- ◇ COPY 17J Backe
- ◇ COPY Mâchoire 17J
- ◇ COPY Quijada 17J
- ◇ COPY Garra 17J

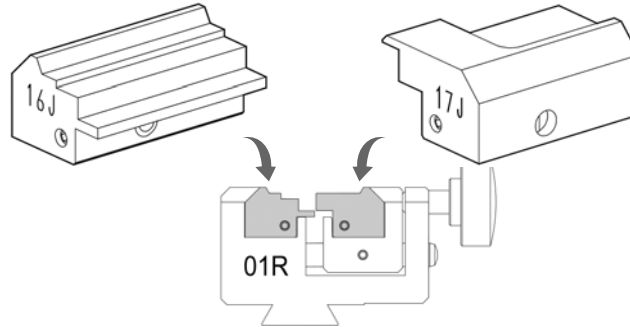

STANDARD D747838ZB



- Cutter 01LW
- Fresa 01LW
- Fräser 01LW
- Fraise 01LW
- Fresa 01LW
- Fresa 01LW

OPTIONAL D742606ZB



- Cutter 01L
- Fresa 01L
- Fräser 01L
- Fraise 01L
- Fresa 01L
- Fresa 01L

PER:
FOR:

ISEO (IT)

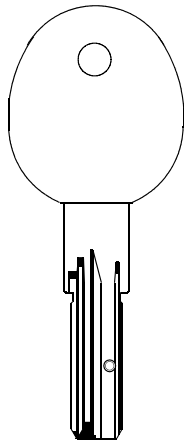

(ISR100 WEB / R100 / R50)

OPTIONAL D743278ZB

- ◆ CODE 11J Jaw
- ◆ CODE Ganascia 11J
- ◇ COPY 11J Backe
- ◇ COPY Mâchoire 11J
- ◇ COPY Quijada 11J
- ◇ COPY Garra 11J

STANDARD D943254ZR

- ◆ CODE 02J Jaw
- ◆ CODE Ganascia 02J
- ◇ COPY 02J Backe
- ◇ COPY Mâchoire 02J
- ◇ COPY Quijada 02J
- ◇ COPY Garra 02J

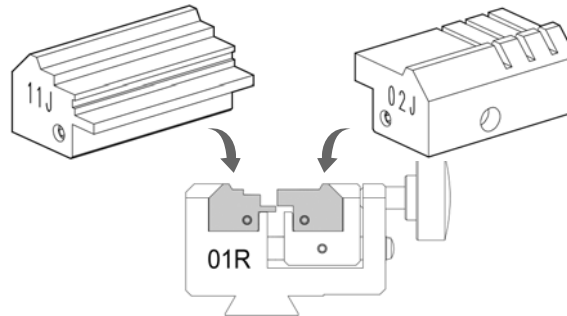

STANDARD D742867ZB



- Cutter 01D
- Fresa 01D
- Fräser 01D
- Fraise 01D
- Fresa 01D
- Fresa 01D

Codes tables protected by a password issued by Silca on receipt of the manufacturer's authorization.

Tablelle codici protette da password rilasciata da Silca a fronte di autorizzazione del costruttore.

Code-Tabellen geschützt durch von Silca geliefertes Passwort auf Herstellergenehmigung.

Tables de codes protégées par un password qui est émis par Silca sur autorisation du Constructeur.

Tablas códigos protegidos con contraseña que manda Silca previa autorización.

Tabelas de códigos protegidas por uma password emitida por Silca contra autorização do fabricante.

PER:
FOR:

KABA (CH)



(maTriX)
(K59)

OPTIONAL D744295ZB

◆ **CODE**
33J Jaw
Ganascia 33J
33J Backe
Mâchoire 33J
Quijada 33J
Garra 33J



OPTIONAL D744296ZB

◆ **CODE**
34J Jaw
Ganascia 34J
34J Backe
Mâchoire 34J
Quijada 34J
Garra 34J

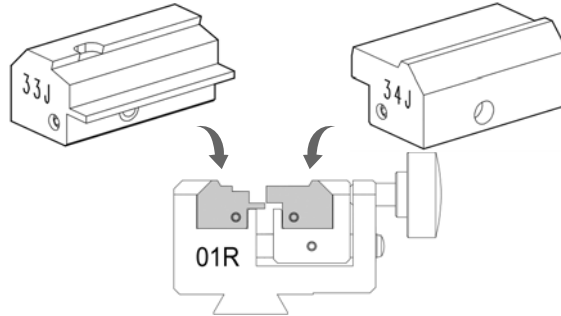

STANDARD



D742867ZB

Cutter 01D
Fresa 01D
Fräser 01D
Fraise 01D
Fresa 01D
Fresa 01D

PER:
FOR:

KABA (CH)

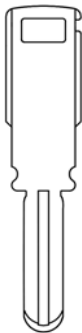

(KABA Exper T)

OPTIONAL



D746713ZB

Clamp 05R
Morsetto 05R
Spannbacke 05R
Etau 05R
Mordaza 05R
Mordente 05R

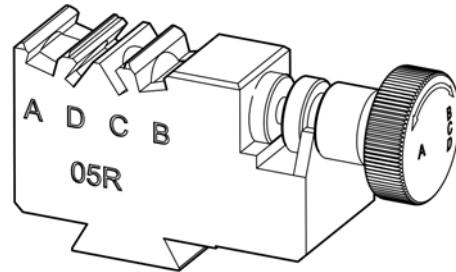

OPTIONAL



D746736ZB

Cutter 10D
Fresa 10D
Fräser 10D
Fraise 10D
Fresa 10D
Fresa 10D

System protected by a password issued by Silca on receipt of authorization.

Sistema protetto da password rilasciata da Silca a fronte di autorizzazione.

System geschützt durch von Silca geliefertes Password auf Genehmigung.

Système protégé par un password qui est émis par Silca sur autorisation.

Sistema protegido con contraseña que manda Silca previa autorización.

Sistema protegido por uma password emitida por Silca contra a autorização.

PER:
FOR:

KABA (CH)

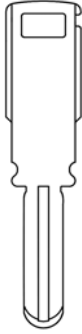

(MaTriX Plus)
(MaTriX Entro)

System protected by a password issued by Silca on receipt of authorization.

Sistema protetto da password rilasciata da Silca a fronte di autorizzazione.

Sysyem geschützt durch von Silca geliefertes Password auf Genehmigung.

Système protégé par un password qui est émis par Silca sur autorisation.

Sistema protegido con contraseña que manda Silca previa autorización.

Sistema protegido por uma password emitida por Silca contra a autorização.

OPTIONAL



D751854ZB

Clamp 06R
Morsetto 06R
Spannbacke 06R
Etau 06R
Mordaza 06R
Mordente 06R

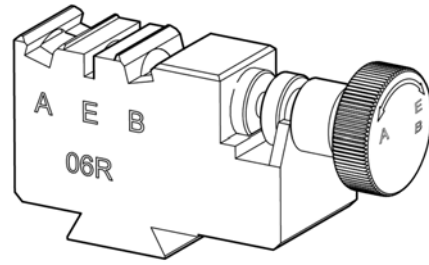

OPTIONAL



D746736ZB

Cutter 10D
Fresa 10D
Fräser 10D
Fraise 10D
Fresa 10D
Fresa 10D

PER:
FOR:

KABA (CH)

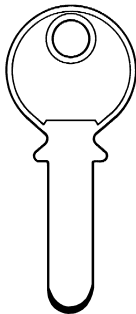

(Kaba 20)
(Kaba Star)

SYSTEM	CARD	SN
Kaba 20	1514	154
Kaba Star	1566	304

OPTIONAL



D7A0192ZB

Clamp 07R
Morsetto 07R
Spannbacke 07R
Etau 07R
Mordaza 07R
Mordente 07R

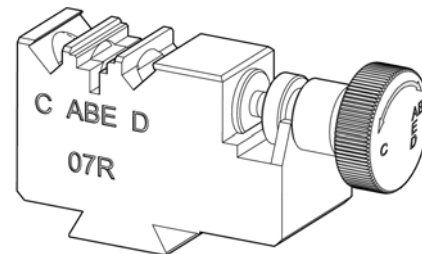

OPTIONAL



D7A1149ZB

Cutter 23D
Fresa 23D
Fräser 23D
Fraise 23D
Fresa 23D
Fresa 23D

OPTIONAL



D748724ZB

Cutter 17D
Fresa 17D
Fräser 17D
Fraise 17D
Fresa 17D
Fresa 17D

PER:
FOR:

KABA (CH)

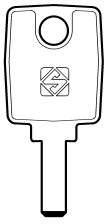

KA8
(KABA-MICRO)

OPTIONAL



D729845ZB

A18 adapter
Adattatore A18
Adapter A18
Adaptateur A18
Adaptador A18
Adaptador A18

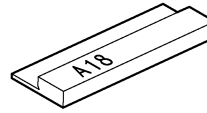

STANDARD



D943253ZR

01J Jaw
Ganascia 01J
01J Backe
Mâchoire 01J
Quijada 01J
Garra 01J

STANDARD



D943254ZR

02J Jaw
Ganascia 02J
02J Backe
Mâchoire 02J
Quijada 02J
Garra 02J

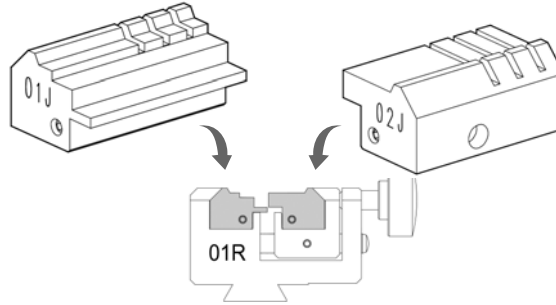

STANDARD



D742867ZB

Cutter 01D
Fresa 01D
Fräser 01D
Fraise 01D
Fresa 01D
Fresa 01D

PER:
FOR:

KABA (CH)



(Miwa)

OPTIONAL

D748720ZB



84J Jaw
Ganascia 84J
84J Backe
Mâchoire 84J
Quijada 84J
Garra 84J

OPTIONAL

D748722ZB



85J Jaw
Ganascia 85J
85J Backe
Mâchoire 85J
Quijada 85J
Garra 85J

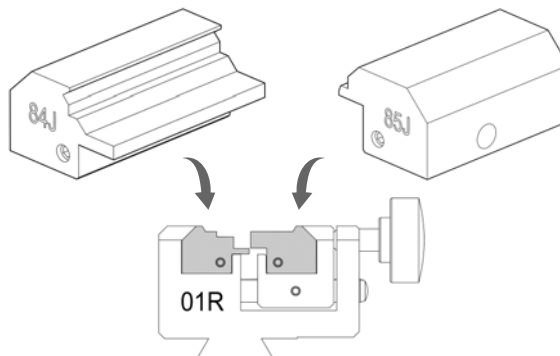

OPTIONAL



D748724ZB

Cutter 17D
Fresa 17D
Fräser 17D
Fraise 17D
Fresa 17D
Fresa 17D

FUTURA PRO UNLIMITED

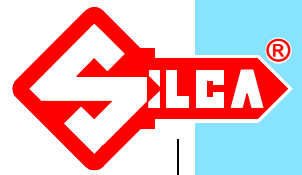

PER:
FOR:

KESO (CH)

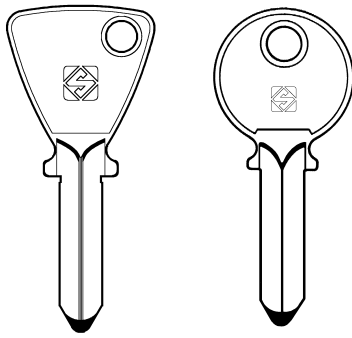

KE1

KE2

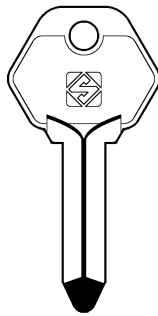

KE4

(1000 System)

OPTIONAL D744291ZB



26J Jaw
Ganascia 26J
26J Backe
Mâchoire 26J
Quijada 26J
Garra 26J

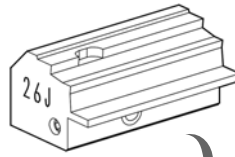

OPTIONAL D744292ZB



27J Jaw
Ganascia 27J
27J Backe
Mâchoire 27J
Quijada 27J
Garra 27J

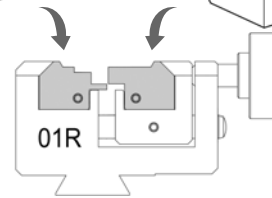
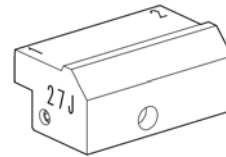

STANDARD



D742867ZB

Cutter 01D
Fresa 01D
Fräser 01D
Fraise 01D
Fresa 01D
Fresa 01D

OPTIONAL



D743674ZB

Cutter 03D
Fresa 03D
Fräser 03D
Fraise 03D
Fresa 03D
Fresa 03D

PER:
FOR:

KYR (IT)

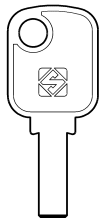

SCU1

SECURITAL

OPTIONAL



D729845ZB

A18 adapter
Adattatore A18
Adapter A18
Adaptateur A18
Adaptador A18
Adaptador A18

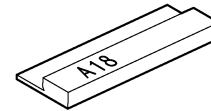

STANDARD



D943253ZR

01J Jaw
Ganascia 01J
01J Backe
Mâchoire 01J
Quijada 01J
Garra 01J

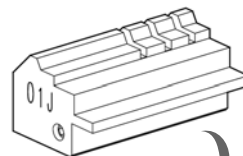

STANDARD



D943254ZR

02J Jaw
Ganascia 02J
02J Backe
Mâchoire 02J
Quijada 02J
Garra 02J

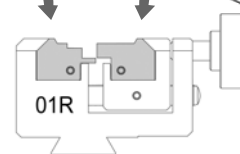
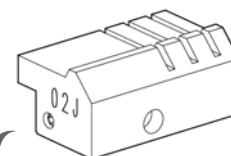

STANDARD



D742867ZB

Cutter 01D
Fresa 01D
Fräser 01D
Fraise 01D
Fresa 01D
Fresa 01D



FUTURA PRO UNLIMITED



PER:
FOR:

MAGNUM (GB)

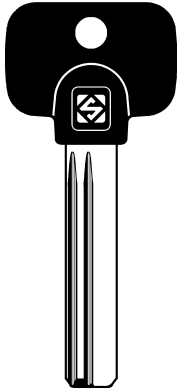

MGN1RP

Magnum Superior
(5+4) (4+3) (3+2)

Magnum Superior +
(5+4) (4+3) (3+2)

OPTIONAL D744363ZB



35J Jaw
Ganascia 35J
35J Backe
Mâchoire 35J
Quijada 35J
Garra 35J



OPTIONAL D744365ZB



36J Jaw
Ganascia 36J
36J Backe
Mâchoire 36J
Quijada 36J
Garra 36J

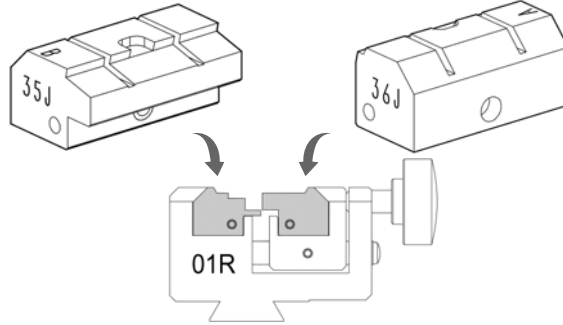

OPTIONAL



D743673ZB

Cutter 02D
Fresa 02D
Fräser 02D
Fraise 02D
Fresa 02D
Fresa 02D

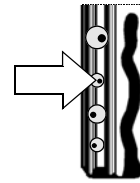

STANDARD D943253ZR



01J Jaw
Ganascia 01J
01J Backe
Mâchoire 01J
Quijada 01J
Garra 01J



STANDARD D943254ZR



02J Jaw
Ganascia 02J
02J Backe
Mâchoire 02J
Quijada 02J
Garra 02J

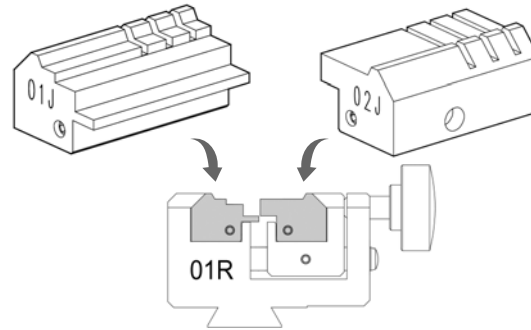

OPTIONAL



D743745ZB

Cutter 04L
Fresa 04L
Fräser 04L
Fraise 04L
Fresa 04L
Fresa 04L

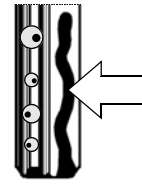

PER:
FOR: **MAUER (BG)**



(NW4)

OPTIONAL
D745192ZB
 54J Jaw
 Ganascia 54J
 54J Backe
 Mâchoire 54J
 Quijada 54J
 Garra 54J

OPTIONAL
D745194ZB
 55J Jaw
 Ganascia 55J
 55J Backe
 Mâchoire 55J
 Quijada 55J
 Garra 55J

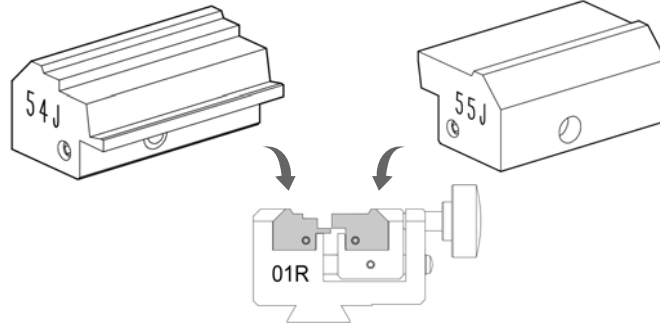

OPTIONAL
D743673ZB
 Cutter 02D
 Fresa 02D
 Fräser 02D
 Fraise 02D
 Fresa 02D
 Fresa 02D

PER:
FOR: **M&C (RO)**

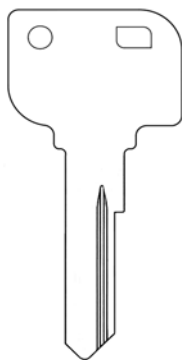

(Matrix)

OPTIONAL
D747169ZB
 66J Jaw
 Ganascia 66J
 66J Backe
 Mâchoire 66J
 Quijada 66J
 Garra 66J

OPTIONAL
D747171ZB
 67J Jaw
 Ganascia 67J
 67J Backe
 Mâchoire 67J
 Quijada 67J
 Garra 67J

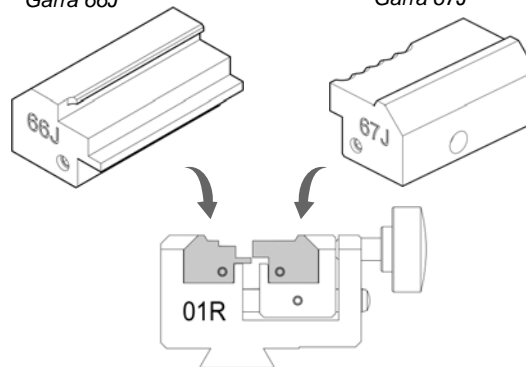

OPTIONAL
D743744ZB
 Cutter 05L
 Fresa 05L
 Fräser 05L
 Fraise 05L
 Fresa 05L
 Fresa 05L

System protected by a password issued by Silca on receipt of authorization.

Sistema protetto da password rilasciata da Silca a fronte di autorizzazione.

System geschützt durch von Silca geliefertes Password auf Genehmigung.

Système protégé par un password qui est émis par Silca sur autorisation.

Sistema protegido con contraseña que manda Silca previa autorización.

Sistema protegido por uma password emitida por Silca contra a autorização.

Note: standard cutting is also required.
 Nota: è necessaria anche la cifratura standard.
 Hinweis: Standard Fräsung ist auch erforderlich.
 Remarque: il faut aussi nécessaire le taillage standard.
 Nota: también es necesario el corte estándar.
 Observação: o corte standard es também necessário

PER:
FOR:

M&C (RO)

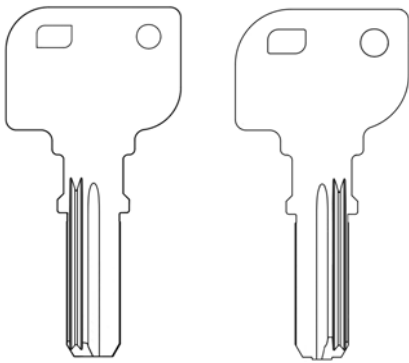

(Condor)

(Condor Mirror)

System protected by a password issued by Silca on receipt of authorization.

Sistema protetto da password rilasciata da Silca a fronte di autorizzazione.

System geschützt durch von Silca geliefertes Password auf Genehmigung.

Système protégé par un password qui est émis par Silca sur autorisation.

Sistema protegido con contraseña que manda Silca previa autorización.

Sistema protegido por uma password emitida por Silca contra a autorização.

OPTIONAL



D752826ZB

104 Jaw
Ganascia 104
104 Backe
Mâchoire 104
Quijada 104
Garra 104

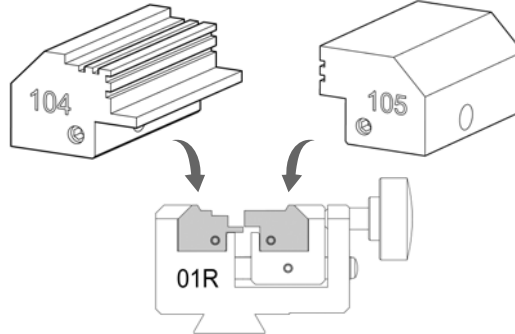

OPTIONAL



D752828ZB

105 Jaw
Ganascia 105
105 Backe
Mâchoire 105
Quijada 105
Garra 105

STANDARD

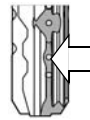

D742867ZB

Cutter 01D
Fresa 01D
Fräser 01D
Fraise 01D
Fresa 01D
Fresa 01D



STANDARD

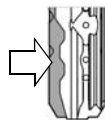

D747838ZB

Cutter 01LW
Fresa 01LW
Fräser 01LW
Fraise 01LW
Fresa 01LW
Fresa 01LW

PER:
FOR:

M&C (RO)

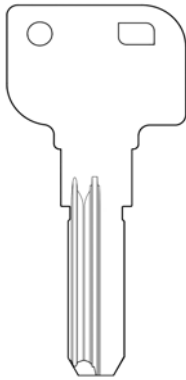

(Color New)
(3+3)
(2T-5W)

System protected by a password issued by Silca on receipt of authorization.

Sistema protetto da password rilasciata da Silca a fronte di autorizzazione.

System geschützt durch von Silca geliefertes Password auf Genehmigung.

Système protégé par un password qui est émis par Silca sur autorisation.

Sistema protegido con contraseña que manda Silca previa autorización.

Sistema protegido por uma password emitida por Silca contra a autorização.

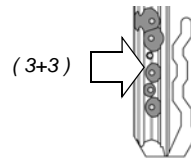

OPTIONAL D751453ZB

• **CODE**
◊ **COPY**

95J Jaw
Ganascia 95J
95J Backe
Mâchoire 95J
Quijada 95J
Garra 95J

OPTIONAL D751455ZB

• **CODE**
◊ **COPY**

96J Jaw
Ganascia 96J
96J Backe
Mâchoire 96J
Quijada 96J
Garra 96J

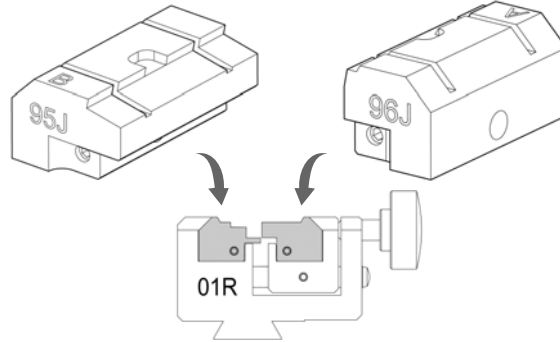

STANDARD



D742867ZB

Cutter 01D
Fresa 01D
Fräser 01D
Fraise 01D
Fresa 01D
Fresa 01D

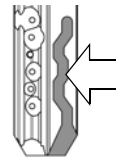

(2T-5W)

STANDARD D943253ZR

• **CODE**
◊ **COPY**

01J Jaw
Ganascia 01J
01J Backe
Mâchoire 01J
Quijada 01J
Garra 01J

STANDARD D943254ZR

• **CODE**
◊ **COPY**

02J Jaw
Ganascia 02J
02J Backe
Mâchoire 02J
Quijada 02J
Garra 02J

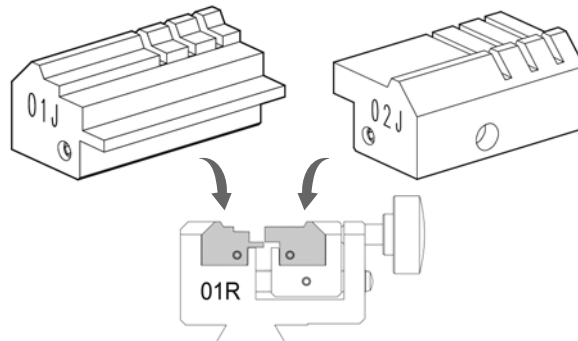

OPTIONAL



D743745ZB

Cutter 04L
Fresa 04L
Fräser 04L
Fraise 04L
Fresa 04L
Fresa 04L

PER:
FOR:

MERONI (IT)

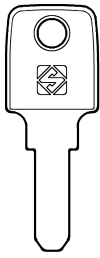

MER39
(M4)

OPTIONAL

D743343ZB

14J Jaw
Ganascia 14J
14J Backe
Mâchoire 14J
Quijada 14J
Garra 14J



OPTIONAL

D743361ZB

15J Jaw
Ganascia 15J
15J Backe
Mâchoire 15J
Quijada 15J
Garra 15J

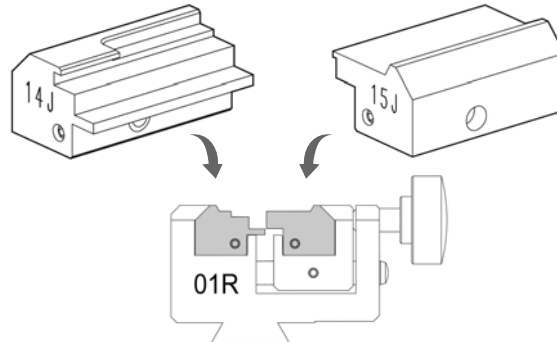

STANDARD



D747839ZB

Cutter 02LW
Fresa 02LW
Fräser 02LW
Fraise 02LW
Fresa 02LW
Fresa 02LW

OPTIONAL



D743671ZB

Cutter 02L
Fresa 02L
Fräser 02L
Fraise 02L
Fresa 02L
Fresa 02L

PER:
FOR:

MG MONTI (IT)

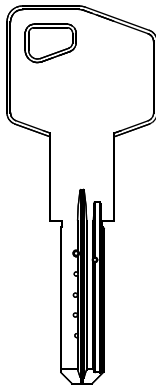

(HSP)

OPTIONAL

D744491ZB

42J Jaw
Ganascia 42J
42J Backe
Mâchoire 42J
Quijada 42J
Garra 42J



OPTIONAL

D744493ZB

43J Jaw
Ganascia 43J
43J Backe
Mâchoire 43J
Quijada 43J
Garra 43J

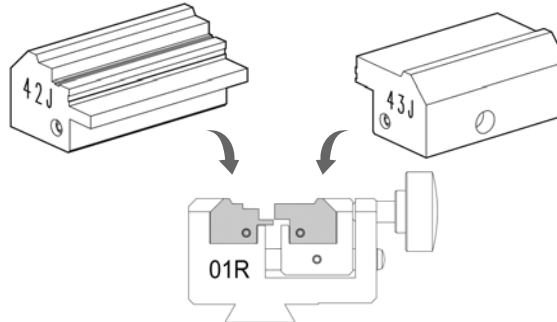

STANDARD



D742867B

Cutter 01D
Fresa 01D
Fräser 01D
Fraise 01D
Fresa 01D
Fresa 01D

System protected by a password issued by Silca on receipt of authorization.

Sistema protetto da password rilasciata da Silca a fronte di autorizzazione.

System geschützt durch von Silca geliefertes Password auf Genehmigung.

Système protégé par un password qui est émis par Silca sur autorisation.

Sistema protegido con contraseña que manda Silca previa autorización.

Sistema protegido por una password emitida por Silca contra a autorização.

PER:
FOR: **MUL.T.LOCK (IL)**

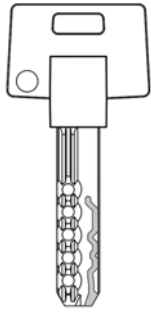

MT5 + (L)
MT5 + (R)

STANDARD



D943253ZR

01J Jaw
Ganascia 01J
01J Backe
Mâchoire 01J
Quijada 01J
Garra 01J

STANDARD



D943254ZR

02J Jaw
Ganascia 02J
02J Backe
Mâchoire 02J
Quijada 02J
Garra 02J

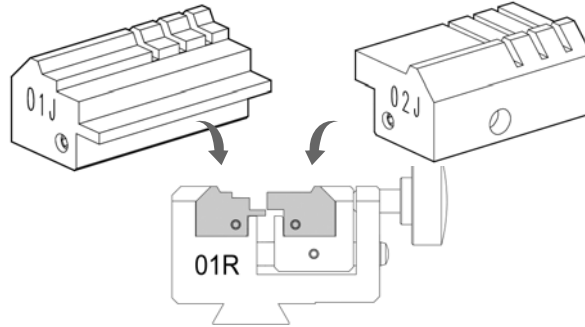

OPTIONAL



D745913ZB

Tracer point 05T
Tastatore 05T
Taster 05T
Palpeur 05T
Palpador 05T
Palpador 05T

OPTIONAL

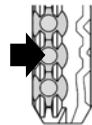

D743746ZB

Cutter 04D
Fresa 04D
Fräser 04D
Fraise 04D
Fresa 04D
Fresa 04D

OPTIONAL

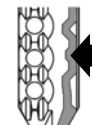

D743744ZB

Cutter 05L
Fresa 05L
Fräser 05L
Fraise 05L
Fresa 05L
Fresa 05L

PER:
FOR: **PFAFFENHAIN (DE)**

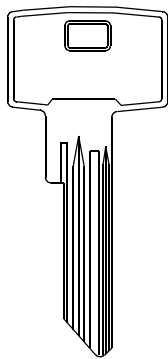

(K14)

OPTIONAL



D744309ZB

24J Jaw
Ganascia 24J
24J Backe
Mâchoire 24J
Quijada 24J
Garra 24J

OPTIONAL



D744311ZB

25J Jaw
Ganascia 25J
25J Backe
Mâchoire 25J
Quijada 25J
Garra 25J

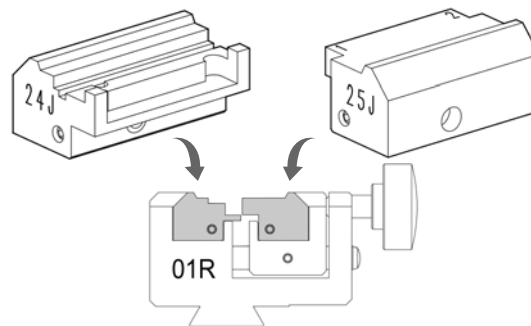

STANDARD



D742867ZB

Cutter 01D
Fresa 01D
Fräser 01D
Fraise 01D
Fresa 01D
Fresa 01D

STANDARD



D942846ZR

01V clamp
Morsetto 01V
Spannbacke 01V
Etau 01V
Mordaza 01V
Mordente 01V

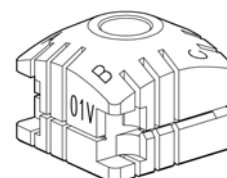

PER:
FOR: **PFAFFENHAIN (DE)**

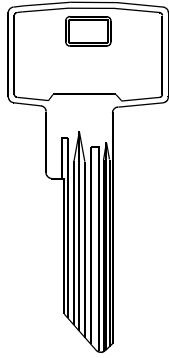

(KV14 - XY14)
(KV14 - XV14)

OPTIONAL



D744313ZB

28J Jaw
Ganascia 28J
28J Backe
Mâchoire 28J
Quijada 28J
Garra 28J

OPTIONAL



D744311ZB

25J Jaw
Ganascia 25J
25J Backe
Mâchoire 25J
Quijada 25J
Garra 25J

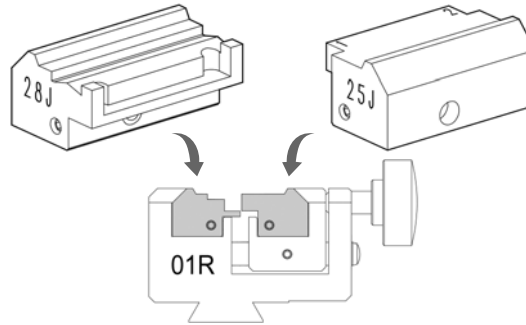

STANDARD



D742867ZB

Cutter 01D
Fresa 01D
Fräser 01D
Fraise 01D
Fresa 01D
Fresa 01D

OPTIONAL



D744373ZB

Clamp 04V
Morsetto 04V
Spannbacke 04V
Etau 04V
Mordaza 04V
Mordente 04V

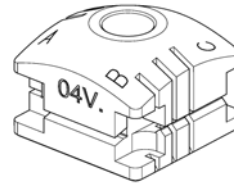

PER:
FOR: **SECUREMME (IT)**

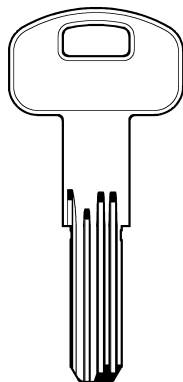

SCM2
(K1)

OPTIONAL



D743341ZB

13J Jaw
Ganascia 13J
13J Backe
Mâchoire 13J
Quijada 13J
Garra 13J

STANDARD



D943254ZR

02J Jaw
Ganascia 02J
02J Backe
Mâchoire 02J
Quijada 02J
Garra 02J

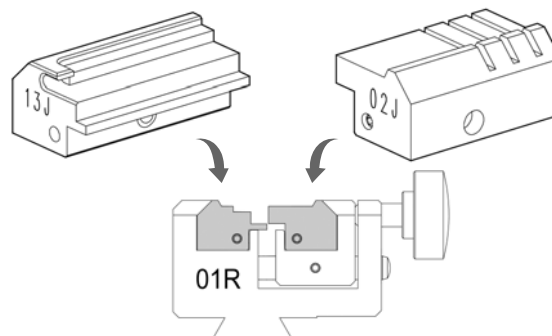

OPTIONAL



D743673ZB

Cutter 02D
Fresa 02D
Fräser 02D
Fraise 02D
Fresa 02D
Fresa 02D

PER:
FOR: **SECUREMME (IT)**

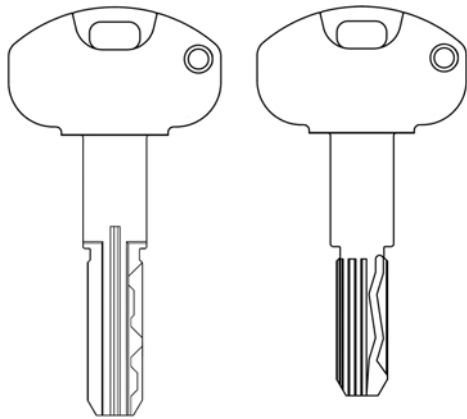

(K3)
5 pin



(K3)
5+5 pin

OPTIONAL

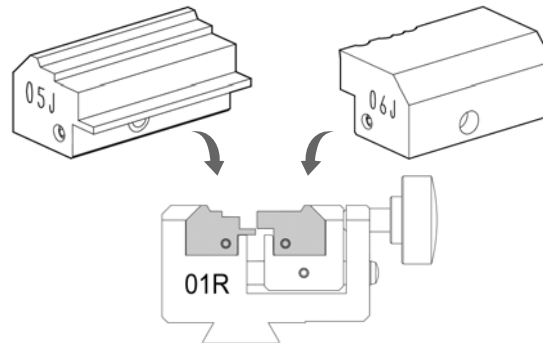

D743261ZB
05J Jaw
Ganascia 05J
05J Backe
Mâchoire 05J
Quijada 05J
Garra 05J

D743262ZB
06J Jaw
Ganascia 06J
06J Backe
Mâchoire 06J
Quijada 06J
Garra 06J





OPTIONAL

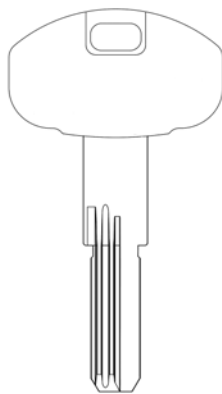

D743673ZB
Cutter 02D
Fresa 02D
Fräser 02D
Fraise 02D
Fresa 02D
Fresa 02D

PER:
FOR: **SECUREMME (IT)**



(EVO K22) 11 pin
(EVO K64) 10 pin 11pin)

OPTIONAL



D743341ZB
13J Jaw
Ganascia 13J
13J Backe
Mâchoire 13J
Quijada 13J
Garra 13J

STANDARD



D943254ZR
02J Jaw
Ganascia 02J
02J Backe
Mâchoire 02J
Quijada 02J
Garra 02J

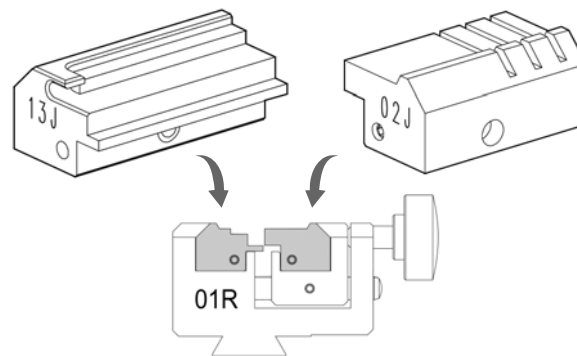

OPTIONAL



D747004ZB
Cutter 14D
Fresa 14D
Fräser 14D
Fraise 14D
Fresa 14D
Fresa 14D

System protected by a password issued by Silca on receipt of authorization.

Sistema protetto da password rilasciata da Silca a fronte di autorizzazione.

System geschützt durch von Silca geliefertes Password auf Genehmigung.

Système protégé par un password qui est émis par Silca sur autorisation.

Sistema protegido con contraseña que manda Silca previa autorización.

Sistema protegido por uma password emitida por Silca contra a autorização.

PER:
FOR: **SECUREMME (IT)**

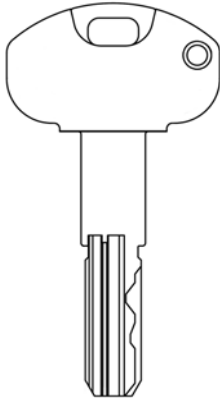

(K5)

6 pin

System protected by a password issued by Silca on receipt of authorization.

Sistema protetto da password rilasciata da Silca a fronte di autorizzazione.

System geschützt durch von Silca geliefertes Password auf Genehmigung.

Système protégé par un password qui est émis par Silca sur autorisation.

Sistema protegido con contraseña que manda Silca previa autorización.

Sistema protegido por uma password emitida por Silca contra a autorização.

OPTIONAL D7A2562ZB
 126 Jaw
 Ganascia 126
 126 Backe
 Mâchoire 126
 Quijada 126
 Garra 126

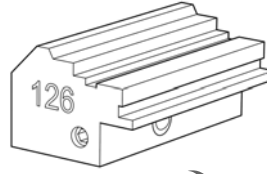

OPTIONAL D7A2563ZB
 127 Jaw
 Ganascia 127
 127 Backe
 Mâchoire 127
 Quijada 127
 Garra 127

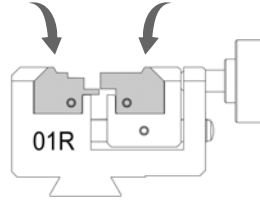
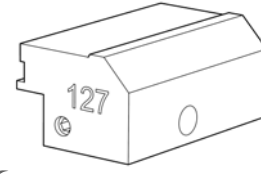

OPTIONAL D743673ZB
 Cutter 02D
 Fresa 02D
 Fräser 02D
 Fraise 02D
 Fresa 02D
 Fresa 02D



OR

OPTIONAL D744017ZB
 18J Jaw
 Ganascia 18J
 18J Backe
 Mâchoire 18J
 Quijada 18J
 Garra 18J

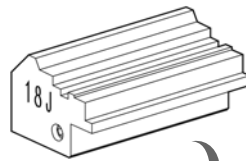

STANDARD D943254ZR
 02J Jaw
 Ganascia 02J
 02J Backe
 Mâchoire 02J
 Quijada 02J
 Garra 02J

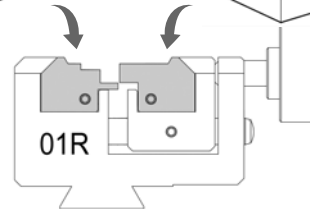
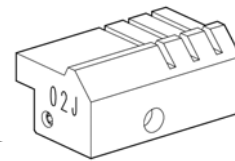

OPTIONAL D743673ZB
 Cutter 02D
 Fresa 02D
 Fräser 02D
 Fraise 02D
 Fresa 02D
 Fresa 02D



PER:
FOR: **SECUREMME (IT)**

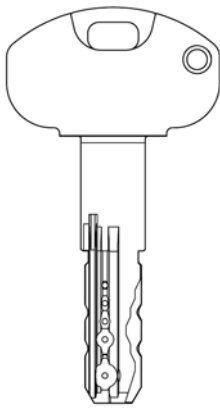

(EVO K50)

System protected by a password issued by Silca on receipt of authorization.

Sistema protetto da password rilasciata da Silca a fronte di autorizzazione.

System geschützt durch von Silca geliefertes Password auf Genehmigung.

Système protégé par un password qui est émis par Silca sur autorisation.

Sistema protegido con contraseña que manda Silca previa autorización.

Sistema protegido por uma password emitida por Silca contra a autorização.

OPTIONAL **D7A2562ZB**



126 Jaw
Ganascia 126
126 Backe
Mâchoire 126
Quijada 126
Garra 126



OPTIONAL **D7A2563ZB**



127 Jaw
Ganascia 127
127 Backe
Mâchoire 127
Quijada 127
Garra 127

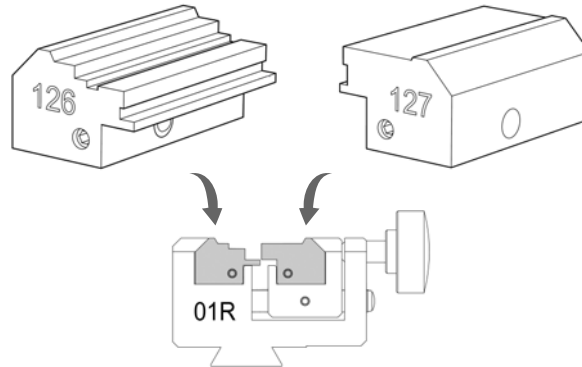

OPTIONAL



D742867ZB

Cutter 01D
Fresa 01D
Fräser 01D
Fraise 01D
Fresa 01D
Fresa 01D

OPTIONAL



D743746ZB

Cutter 04D
Fresa 04D
Fräser 04D
Fraise 04D
Fresa 04D
Fresa 04D

PER:
FOR: **STS (ES)**

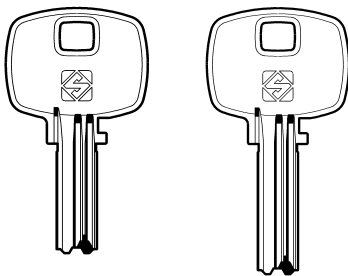

STS5

STS6

OPTIONAL



D743340ZB

12J Jaw
Ganascia 12J
12J Backe
Mâchoire 12J
Quijada 12J
Garra 12J



STANDARD



D943254ZR

02J Jaw
Ganascia 02J
02J Backe
Mâchoire 02J
Quijada 02J
Garra 02J

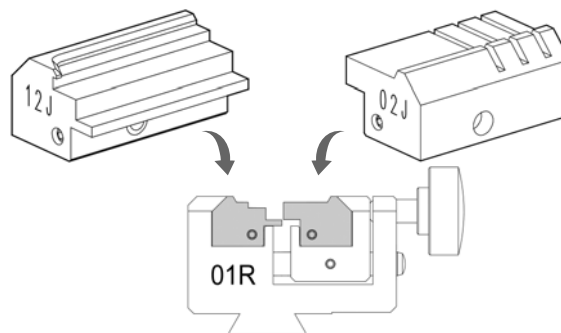

STANDARD



D742867ZB

Cutter 01D
Fresa 01D
Fräser 01D
Fraise 01D
Fresa 01D
Fresa 01D

FUTURA PRO UNLIMIT

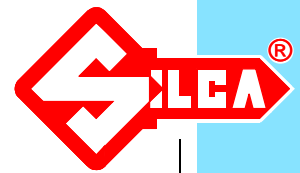

PER:
FOR:

STS (ES)

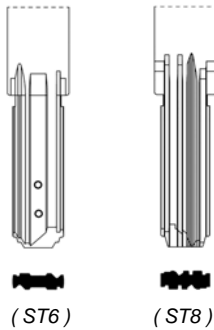

SYSTEM	CARD	SN
ST6	2986	1131
ST8	3006	1151

System protected by a password issued by Silca on receipt of authorization.

Sistema protetto da password rilasciata da Silca a fronte di autorizzazione.

Sysyem geschützt durch von Silca geliefertes Password auf Genehmigung.

Système protégé par un password qui est émis par Silca sur autorisation.

Sistema protegido con contraseña que manda Silca previa autorización.

Sistema protegido por uma password emitida por Silca contra a autorização.

OPTIONAL

D746544ZB



58J Jaw
Ganascia 58J
58J Backe
Mâchoire 58J
Quijada 58J
Garra 58J



OPTIONAL

D746839ZB



61J Jaw
Ganascia 61J
61J Backe
Mâchoire 61J
Quijada 61J
Garra 61J

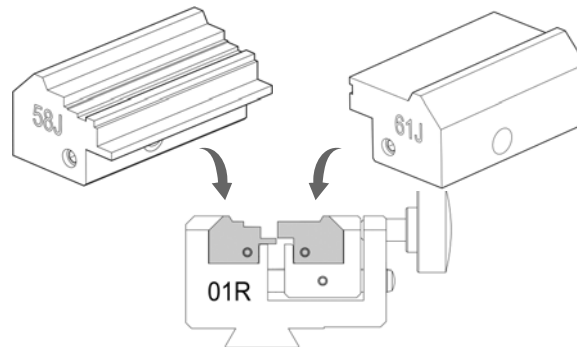

OPTIONAL



D744508ZB

Cutter 09D
Fresa 09D
Fräser 09D
Fraise 09D
Fresa 09D
Fresa 09D

PER:
FOR:

TESA (ES)

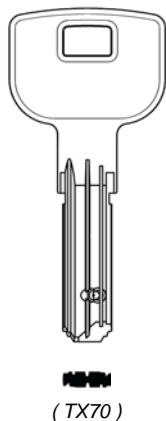

System protected by a password issued by Silca on receipt of authorization.

Sistema protetto da password rilasciata da Silca a fronte di autorizzazione.

Sysyem geschützt durch von Silca geliefertes Password auf Genehmigung.

Système protégé par un password qui est émis par Silca sur autorisation.

Sistema protegido con contraseña que manda Silca previa autorización.

Sistema protegido por uma password emitida por Silca contra a autorização.

OPTIONAL

D751338ZB



94J Jaw
Ganascia 94J
94J Backe
Mâchoire 94J
Quijada 94J
Garra 94J



OPTIONAL

D748361ZB



83J Jaw
Ganascia 83J
83J Backe
Mâchoire 83J
Quijada 83J
Garra 83J

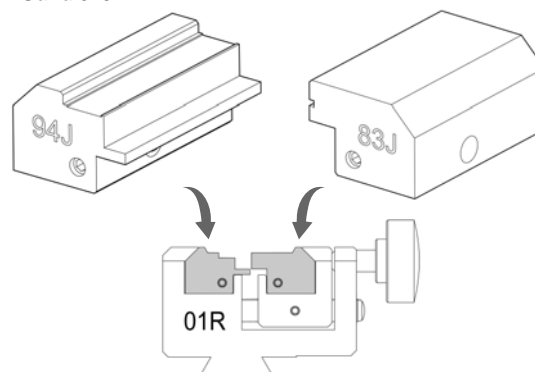

STANDARD



D742867ZB





Cutter 01D
Fresa 01D
Fräser 01D
Fraise 01D
Fresa 01D
Fresa 01D

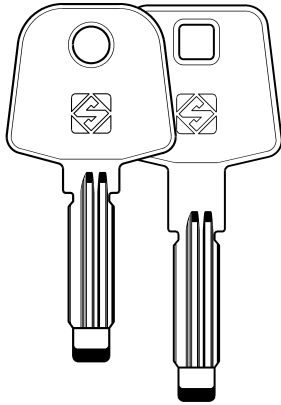

PER:
FOR:

VACHETTE (FR)



 **VAC91** 
 **VAC103** 

(VACHETTE RADIAL)

OPTIONAL



D744287ZB

22J Jaw
Ganascia 22J
22J Backe
Mâchoire 22J
Quijada 22J
Garra 22J

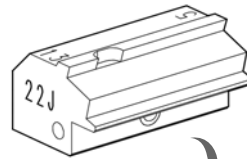

OPTIONAL



D744288ZB

23J Jaw
Ganascia 23J
23J Backe
Mâchoire 23J
Quijada 23J
Garra 23J

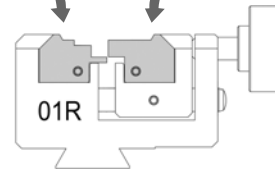
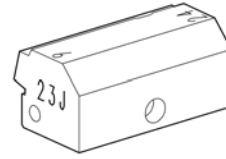

OPTIONAL



D743674ZB

Cutter 03D
Fresa 03D
Fräser 03D
Fraise 03D
Fresa 03D
Fresa 03D

PER:
FOR:

VIRO (IT)



(Palladium)

System protected by a password issued by Silca on receipt of authorization.

Sistema protetto da password rilasciata da Silca a fronte di autorizzazione.

Sysyem geschützt durch von Silca geliefertes Password auf Genehmigung.

Système protégé par un password qui est émis par Silca sur autorisation.

Sistema protegido con contraseña que manda Silca previa autorización.

Sistema protegido por uma password emitida por Silca contra a autorização.

OPTIONAL



D744560ZB

50J Jaw
Ganascia 50J
50J Backe
Mâchoire 50J
Quijada 50J
Garra 50J

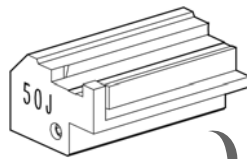

OPTIONAL



D744634ZB

51J Jaw
Ganascia 51J
51J Backe
Mâchoire 51J
Quijada 51J
Garra 51J

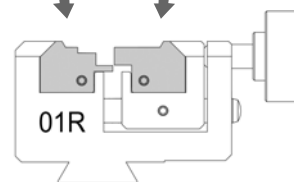
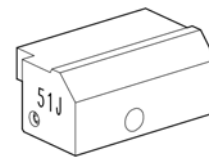

OPTIONAL



D743673ZB

Cutter 02D
Fresa 02D
Fräser 02D
Fraise 02D
Fresa 02D
Fresa 02D

PER:
FOR:

WILKA (DE)

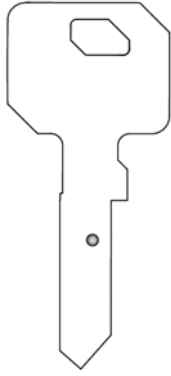

WILKA
(PR100)
(Carat - P1)

OPTIONAL



D744309ZB

24J Jaw
Ganascia 24J
24J Backe
Mâchoire 24J
Quijada 24J
Garra 24J

OPTIONAL



D744311ZB

25J Jaw
Ganascia 25J
25J Backe
Mâchoire 25J
Quijada 25J
Garra 25J

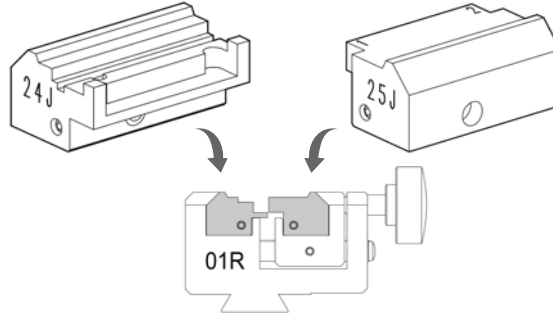

OPTIONAL



D743673ZB

Cutter 02D
Fresa 02D
Fräser 02D
Fraise 02D
Fresa 02D
Fresa 02D

PER:
FOR:

WILKA (DE)

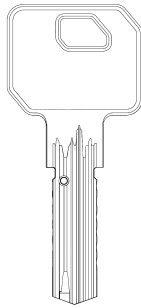

WILKA
(PR300)
(Carat - P3)

OPTIONAL



D744503ZB

48J Jaw
Ganascia 48J
48J Backe
Mâchoire 48J
Quijada 48J
Garra 48J

OPTIONAL



D744501ZB

47J Jaw
Ganascia 47J
47J Backe
Mâchoire 47J
Quijada 47J
Garra 47J

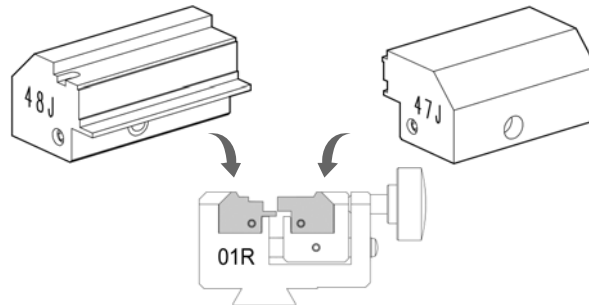

STANDARD



D742867ZB

Cutter 01D
Fresa 01D
Fräser 01D
Fraise 01D
Fresa 01D
Fresa 01D

PER:
FOR:

WILKA (DE)

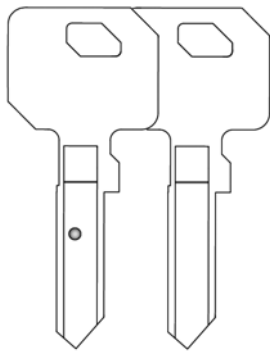

(Carat S1 - Carat S4)

DIMPLE CUTS

SYSTEM	CARD	SN
Carat S1	4358	1980
Carat S4	4358	1986

STANDARD CUTS

SYSTEM	CARD	SN
Carat S1	4357	4838
Carat S4	4357	4839

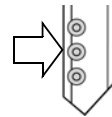

OPTIONAL



D747173ZB

68J jaw
Ganascia 68J
68J Backe
Mâchoire 68J
Quijada 68J
Garra 68J

OPTIONAL



D747175ZB

69J jaw
Ganascia 69J
69J Backe
Mâchoire 69J
Quijada 69J
Garra 69J

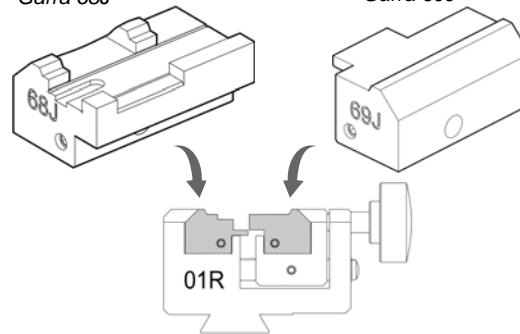

OPTIONAL



D743673ZB

Cutter 02D
Fresa 02D
Fräser 02D
Fraise 02D
Fresa 02D
Fresa 02D

OPTIONAL

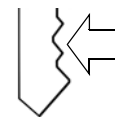

D752566ZB

B16 adapter
Adattatore B16
B16 Adapter
Adaptateur B16
Adaptador B16
Adaptador B16

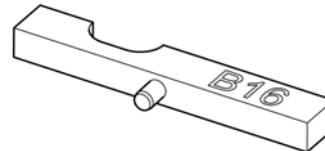

PER:
FOR:

WILKA (DE)

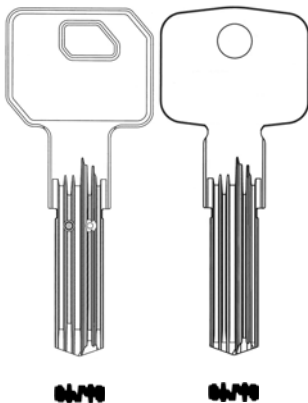

(Carat S3 - Carat S5)

SYSTEM	CARD	SN
Carat S3	4359	1983
Carat S5	4359	1984

OPTIONAL



D7A0899ZB

110 jaw
Ganascia 110
110 Backe
Mâchoire 110
Quijada 110
Garra 110

OPTIONAL



D7A0900ZB

111 jaw
Ganascia 111
111 Backe
Mâchoire 111
Quijada 111
Garra 111

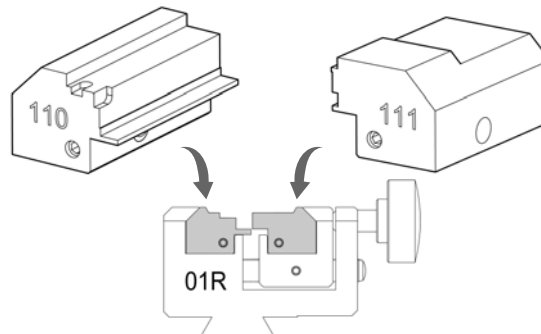

OPTIONAL



D744508ZB

Cutter 09D
Fresa 09D
Fräser 09D
Fraise 09D
Fresa 09D
Fresa 09D

PER: **WINKHAUS (DE)**
FOR:

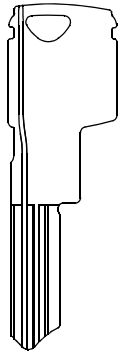

(RPE - RPS)

System protected by a password issued by Silca on receipt of authorization.

Sistema protetto da password rilasciata da Silca a fronte di autorizzazione.

System geschützt durch von Silca geliefertes Password auf Genehmigung.

Système protégé par un password qui est émis par Silca sur autorisation.

Sistema protegido con contraseña que manda Silca previa autorización.

Sistema protegido por uma password emitida por Silca contra a autorização.

OPTIONAL **D744309ZB**



24J Jaw
Ganascia 24J
24J Backe
Mâchoire 24J
Quijada 24J
Garra 24J



OPTIONAL **D744311ZB**



25J Jaw
Ganascia 25J
25J Backe
Mâchoire 25J
Quijada 25J
Garra 25J

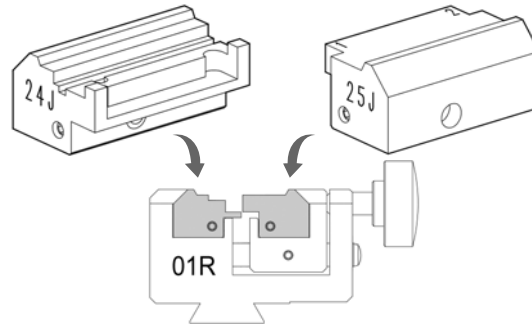

OPTIONAL



D744353ZB

Cutter 06D
Fresa 06D
Fräser 06D
Fraise 06D
Fresa 06D
Fresa 06D

OPTIONAL



D744369ZB

Clamp 03V
Morsetto 03V
Spannbacke 03V
Etau 03V
Mordaza 03V
Mordente 03V

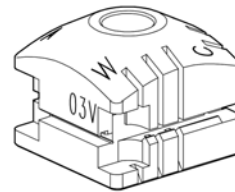







FUTURA PRO UNLIMITED



PER:
FOR:

AUDI (DE)
FORD (DE)
PORSCHE (DE)
SEAT (ES)
SKODA (CZ)
VOLKSWAGEN (DE)



 HU66MH	 HU66P	 HU66AT5 HU66AT6
 HU66EHP	HU66T5 HU66T6	 HU66CT5
 HU66FH	HU66T10 HU66T15 HU66T23 HU66T26 HU66T28	HU66DT5 HU66CT6 HU66BT1 HU66BT15 HU66BT28
 HU75T	HU66TE	HU66BT28

HUF (D) - WITTE (D)

STANDARD



D744023ZB

19J Jaw
Ganascia 19J
19J Backe
Mâchoire 19J
Quijada 19J
Garra 19J

STANDARD



D943254ZR

02J Jaw
Ganascia 02J
02J Backe
Mâchoire 02J
Quijada 02J
Garra 02J

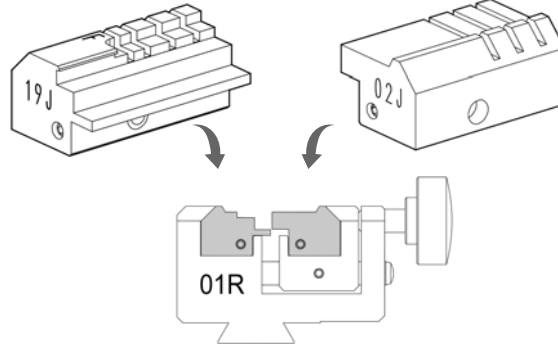

STANDARD



D747838ZB

Cutter 01LW
Fresa 01LW
Fräser 01LW
Fraise 01LW
Fresa 01LW
Fresa 01LW

OPTIONAL



D742606ZB

Cutter 01L
Fresa 01L
Fräser 01L
Fraise 01L
Fresa 01L
Fresa 01L



FUTURA PRO UNLIMITED

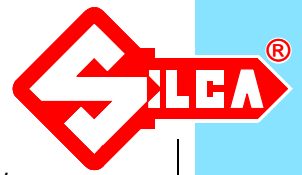

PER:
FOR:

BMW (DE)

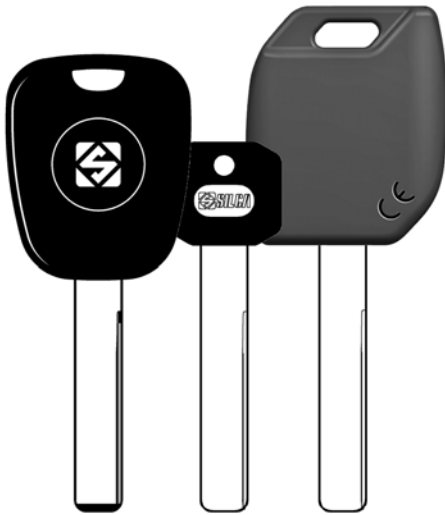

HU92RP **HU92RKP** **HU92RMH**

STANDARD



D943253ZR

01J Jaw
Ganascia 01J
01J Backe
Mâchoire 01J
Quijada 01J
Garra 01J

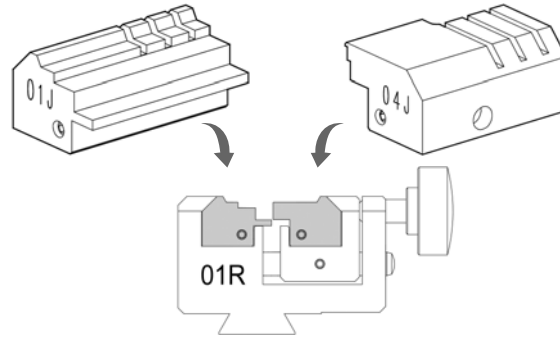

STANDARD



D743256ZB

04J Jaw
Ganascia 04J
04J Backe
Mâchoire 04J
Quijada 04J
Garra 04J

STANDARD



D747838ZB

Cutter 01LW
Fresa 01LW
Fräser 01LW
Fraise 01LW
Fresa 01LW
Fresa 01LW

OPTIONAL



D742606ZB

Cutter 01L
Fresa 01L
Fräser 01L
Fraise 01L
Fresa 01L
Fresa 01L

PER:
FOR:

CITROËN (FR)



SX9CP **SX9GP** **SX9T14** **SX9MH**

SX9AP
SX10BP
SX11BP
SX9EHP

SX9T6
SX9TE

VALEO - SIMPLEX (F)

STANDARD

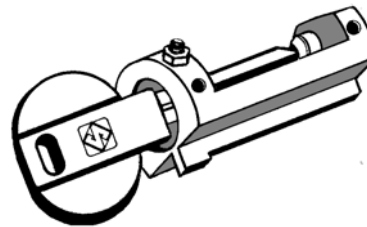

D708040ZB

Code adaptor B6 for SIMPLEX
Adattatore B6 a codice per chiavi SIMPLEX
Code-Adapter B6 für SIMPLEX Schlüssel
Adaptateur B6 à code pour clés SIMPLEX
Adaptador B6 a código para llaves SIMPLEX
Adaptador B6 por código para chaves SIMPLEX



PER:
FOR:

FORD (DE)

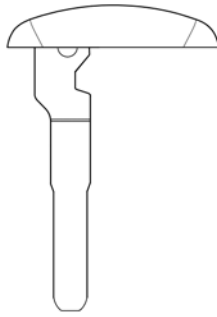

(Escape model)

STANDARD



D741485ZB

A34 adapter
Adattatore A34
Adapter A34
Adaptateur A34
Adaptador A34
Adaptador A34

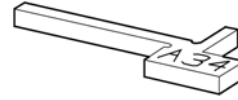

STANDARD



D943253ZR

01J Jaw
Ganascia 01J
01J Backe
Mâchoire 01J
Quijada 01J
Garra 01J

STANDARD



D943254ZR

02J Jaw
Ganascia 02J
02J Backe
Mâchoire 02J
Quijada 02J
Garra 02J

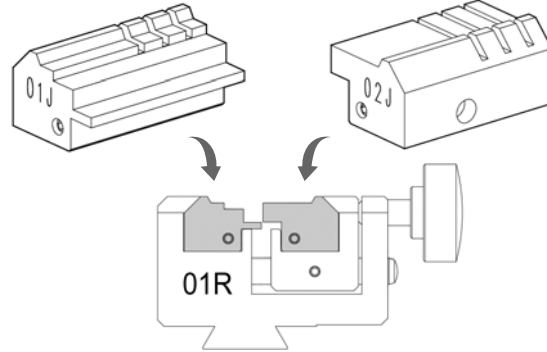

STANDARD



D747838ZB

Cutter 01LW
Fresa 01LW
Fräser 01LW
Fraise 01LW
Fresa 01LW
Fresa 01LW

OPTIONAL



D742606ZB

Cutter 01L
Fresa 01L
Fräser 01L
Fraise 01L
Fresa 01L
Fresa 01L

OR

STANDARD



D744023ZB

19J Jaw
Ganascia 19J
19J Backe
Mâchoire 19J
Quijada 19J
Garra 19J

STANDARD



D943254ZR

02J Jaw
Ganascia 02J
02J Backe
Mâchoire 02J
Quijada 02J
Garra 02J

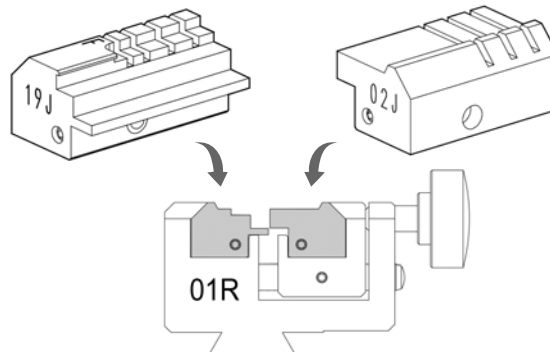

STANDARD



D747838ZB

Cutter 01LW
Fresa 01LW
Fräser 01LW
Fraise 01LW
Fresa 01LW
Fresa 01LW

OPTIONAL



D742606ZB

Cutter 01L
Fresa 01L
Fräser 01L
Fraise 01L
Fresa 01L
Fresa 01L

FUTURA PRO UNLIMITED

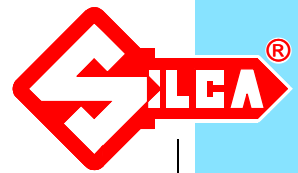

PER:
FOR: **FORD (EU+USA)**

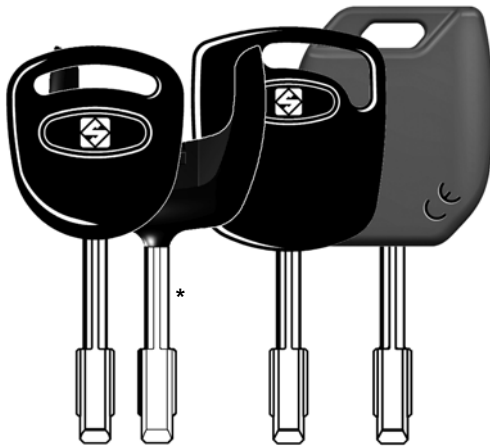

- FO21P
- FO21AP
- FO21T3
- FO21MH
- FO21EH1
- FO21EH2
- FO21T3M
- FO21T7
- FO21T17
- FO21TE
- FO21FH

** IMPORTANT! Key blank to be applied to the original remote control (the remote control includes the transponder chip)*

TIBBE (D)
VALEO (F)

STANDARD



- D743276ZB**
03R Clamp
Morsetto 03R
03R Spannbacke
Etau 03R
Mordaza 03R
Mordente 03R

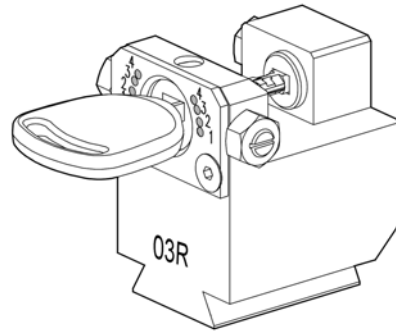

STANDARD



- D747838ZB**
Cutter 01LW
Fresa 01LW
Fräser 01LW
Fraise 01LW
Fresa 01LW
Fresa 01LW

OPTIONAL



- D742606ZB**
Cutter 01L
Fresa 01L
Fräser 01L
Fraise 01L
Fresa 01L
Fresa 01L

PER:
FOR: **HONDA (JP)**

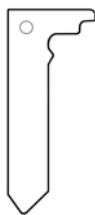

(N-BOX - N-ONE - N-VAGON)
Emergency key

OPTIONAL



- D745037ZB**
52J Jaw
Ganascia 52J
52J Backe
Mâchoire 52J
Quijada 52J
Garra 52J

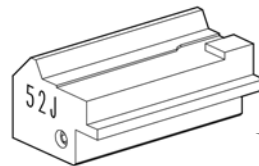

OPTIONAL



- D745039ZB**
53J Jaw
Ganascia 53J
53J Backe
Mâchoire 53J
Quijada 53J
Garra 53J

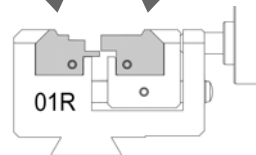
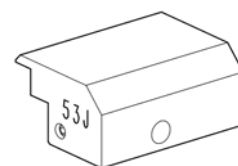

STANDARD



- D747838ZB**
Cutter 01LW
Fresa 01LW
Fräser 01LW
Fraise 01LW
Fresa 01LW
Fresa 01LW

OPTIONAL



- D742606ZB**
Cutter 01L
Fresa 01L
Fräser 01L
Fraise 01L
Fresa 01L
Fresa 01L



FUTURA PRO UNLIMITED



PER:
FOR:

HUF (DE)

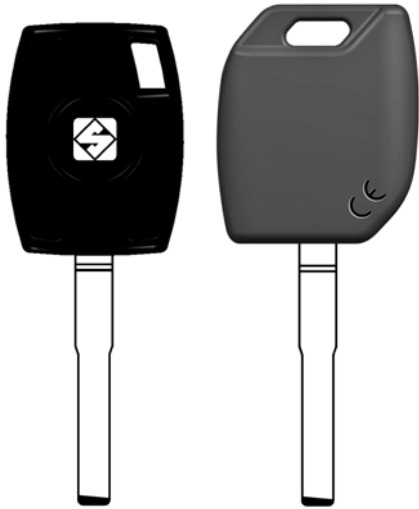

■
HU101T17
HU101T20
HU101TE

■
HU101MH

HU101T
HU101AP
HU101EH
HU101FH

OPTIONAL



D743255ZB

03J Jaw
Ganascia 03J
03J Backe
Mâchoire 03J
Quijada 03J
Garra 03J

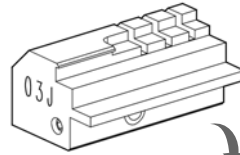

STANDARD



D943254ZR

02J Jaw
Ganascia 02J
02J Backe
Mâchoire 02J
Quijada 02J
Garra 02J

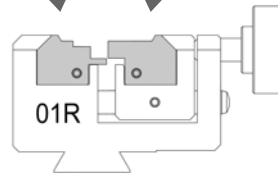
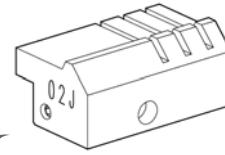

STANDARD



D747838ZB

Cutter 01LW
Fresa 01LW
Fräser 01LW
Fraise 01LW
Fresa 01LW
Fresa 01LW

OPTIONAL



D742606ZB

Cutter 01L
Fresa 01L
Fräser 01L
Fraise 01L
Fresa 01L
Fresa 01L

OR

STANDARD



D744023ZB

19J Jaw
Ganascia 19J
19J Backe
Mâchoire 19J
Quijada 19J
Garra 19J

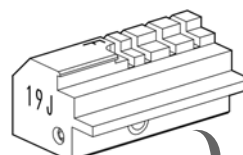

STANDARD



D943254ZR

02J Jaw
Ganascia 02J
02J Backe
Mâchoire 02J
Quijada 02J
Garra 02J

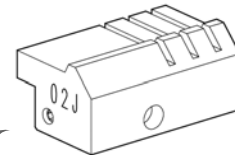

STANDARD



D747838ZB

Cutter 01LW
Fresa 01LW
Fräser 01LW
Fraise 01LW
Fresa 01LW
Fresa 01LW

OPTIONAL



D742606ZB

Cutter 01L
Fresa 01L
Fräser 01L
Fraise 01L
Fresa 01L
Fresa 01L



FUTURA PRO UNLIMITED



PER:
FOR:

HUF (DE)



HU162T
(4T - 8W)

VOLKSWAGEN
SKODA

STANDARD



D746461ZB

56J Jaw
Ganascia 56J
56J Backe
Mâchoire 56J
Quijada 56J
Garra 56J

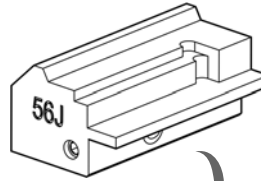

STANDARD



D746467ZB

57J Jaw
Ganascia 57J
57J Backe
Mâchoire 57J
Quijada 57J
Garra 57J

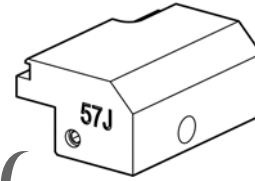

STANDARD



D747839ZB

Cutter 02LW
Fresa 02LW
Fräser 02LW
Fraise 02LW
Fresa 02LW
Fresa 02LW

OPTIONAL



D743671ZB

Cutter 02L
Fresa 02L
Fräser 02L
Fraise 02L
Fresa 02L
Fresa 02L

PER:
FOR:

MERCEDES (DE)



HU41P

HU55P

HU64P

HU61AP

HU64T

HU65AP

HUF (D)

STANDARD



D943253ZR

01J Jaw
Ganascia 01J
01J Backe
Mâchoire 01J
Quijada 01J
Garra 01J

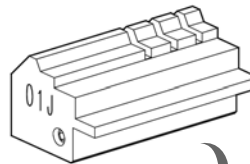

STANDARD



D743256ZB

04J Jaw
Ganascia 04J
04J Backe
Mâchoire 04J
Quijada 04J
Garra 04J

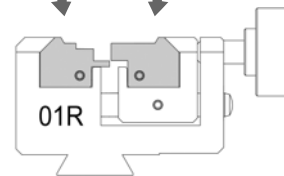
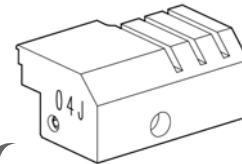

STANDARD



D747838ZB

Cutter 01LW
Fresa 01LW
Fräser 01LW
Fraise 01LW
Fresa 01LW
Fresa 01LW

OPTIONAL



D742606ZB

Cutter 01L
Fresa 01L
Fräser 01L
Fraise 01L
Fresa 01L
Fresa 01L



PER: **TUBULAR KEYS**
 FOR: **CHIAVI TUBOLARI**
STECKSCHLÜSSEL
CLÉS TUBULAIRES
LLAVES TUBOLARES

AGA (ES)
BILMA (ES) BIL1T

CHICAGO (USA) CH9T
 CH16T (9.2)
 CH17T (10)

L&F (GB)
KENSTAN (USA) CH9T

MERONI (IT) MER22T (9.50)
 MER25T (9.50)

P.CORTELLEZZI (IT) PC12T (9.60)
 PC12TP (9.60)
 PC15T (9.60)
 PC15TP (9.60)

SILCA (IT) SLC1TP (9.60)
 SLC2TP (9.60)

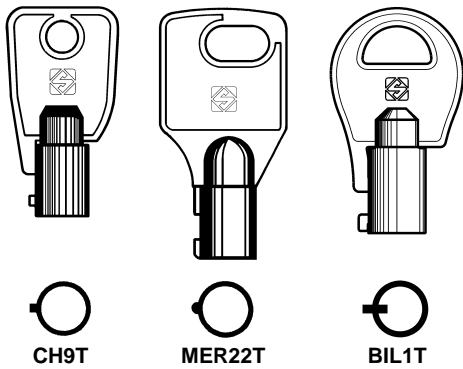

OPTIONAL



D743275ZB
02R Clamp
Morsetto 02R
02R Spannbacke
Etau 02R
Mordaza 02R
Mordente 02R

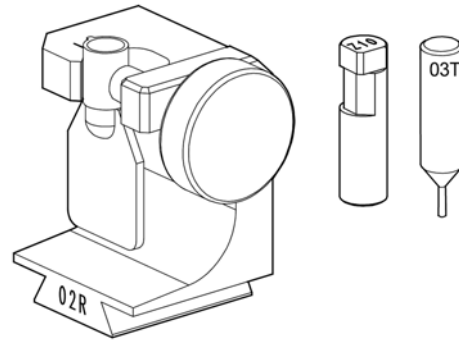

OPTIONAL



D743672ZB
Cutter 03L
Fresa 03L
Fräser 03L
Fraise 03L
Fresa 03L
Fresa 03L

PER: ENGRAVING
FOR:



STANDARD

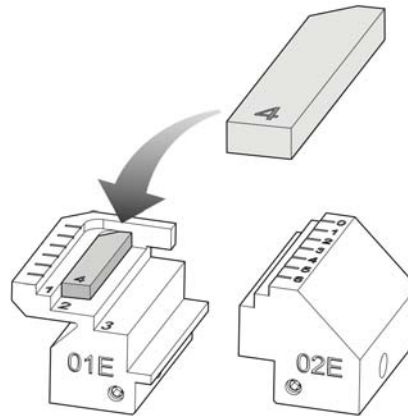

D750763ZB

Adapter plane 4
Adattatore sede 4
Adapter Ebene 4
Adaptateur emplacement 4
Adaptador alojamiento 4
Adaptador alojamiento 4

D748737ZB

01E Jaw
Ganascia 01E
01E Backe
Mâchoire 01E
Quijada 01E
Garra 01E

D748739ZB

02E Jaw
Ganascia 02E
02E Backe
Mâchoire 02E
Quijada 02E
Garra 02E

D748741ZB

Cutter 18DW
Fresa 18DW
Fräser 18DW
Fraise 18DW
Fresa 18DW
Fresa 18DW

PLANE	WIDTH of the object to be engraved	ENGRAVING AREA (max.)
1	min 26 - max 32 mm	32 mm x 40 mm
2	min 20 - max 26 mm	24 mm x 36,5 mm
3	min 8 - max 14 mm	12 mm x 36,5 mm
4	min 14 - max 20 mm	18 mm x 36,5 mm

Thickness of the object to be engraved: max.5,2 mm

